

# BC Energy Step Code Design Guide Supplement S3 on Overheating and Air Quality

June 2019



## About This Supplement

The Design Guide Supplement on Overheating and Air Quality was published by BC Housing in collaboration with BC Hydro, the City of Vancouver, the City of New Westminster, and the Province of BC. It provides information on the key strategies and approaches necessary to reduce the impacts of a warmer climate on mid- and high-rise (Part 3) wood-frame and non-combustible residential buildings within British Columbia. Specifically, it is intended to provide building industry actors, including local governments, public sector organizations, architects, and developers, with an accessible source of information on the key means of addressing issues of overheating and indoor air quality.

This supplement can be used as a stand-alone resource, but is intended to complement the BC Energy Step Code Design Guide and should be consulted alongside the strategies presented to meet the targets under the BC Energy Step Code. Strategies outlined in the guide comply with the BC Energy Step Code across the province, but are also compatible with those projects seeking compliance with the City of Vancouver's Zero Emissions Building Plan.

This supplement is also one in a series of design guides designed to support an industry transition toward a future in which safe, resilient and adaptive buildings are business-as-usual. For more information and access to other resources, guidelines, primers on climate change resilience, and details on the Mobilizing Building Adaptation and Resilience (MBAR) project, visit the BC Housing website at [www.bchousing.org/research-centre](http://www.bchousing.org/research-centre).

## Disclaimer

The greatest care has been taken to confirm the accuracy of the information contained herein. However, the authors, funders, publisher, and other contributors assume no liability for any damage, injury, loss, or expense that may be incurred or suffered as a result of the use of this publication, including products, building techniques, or practices. The views expressed herein do not necessarily represent those of any individual contributor, BC Housing, BC Hydro, the City of New Westminster, the City of Vancouver, or the Province of British Columbia. As products and construction practices change and improve over time, it is advisable to regularly consult up-to-date technical publications on building science, products, and practices, rather than relying solely on this publication. It is also advisable to seek specific information on the use of products, the requirements of good design and construction practices, and the requirements of the applicable building codes before undertaking a construction project. Retain consultants with appropriate engineering or architectural qualifications, as well as the appropriate municipal and other authorities, regarding issues of design and construction practices, and compliance with the British Columbia Building Code (BCBC) and Vancouver's Building By-law (VBBL). The use of this guide does not guarantee compliance with code requirements, nor does the use of systems not covered by this guide preclude compliance.

## Acknowledgements

This guide was funded and commissioned by BC Housing, BC Hydro, the City of Vancouver, the City of New Westminster, and the Province of BC. Acknowledgement is extended to all those who participated in this project as part of the project team or as external reviewers.

### Produced by:

**HCMA Architecture + Design**  
Johnathon Strebly, Bonnie Retief, Judy Bau

**Integral Group**  
Lisa Westerhoff, Chris Doel, Craig Dedels

**Focal Engineering**  
Susan MacDougall, Riley Beise, Sarah Shepherd

### External Reviewers:

**AIBC**  
Maura Gatensby

**Fraser Health**  
Ghazal Ebrahimi, Angie Woo

**BC Housing**  
Wilma Leung, Bill Mackinnon,  
Magda Szpala, Remi Charron

**ICLEI Canada**  
Craig Brown

**BC Hydro**  
Gary Hamer, Toby Lau

**Province of British Columbia**  
Zachary May, Emily Sinclair

**City of New Westminster**  
Norm Connolly

**University of British Columbia**  
Ralph Wells

**City of Vancouver**  
Patrick Enright

**University of Toronto**  
Ted Kesik

**Engineers and Geoscientists BC**  
Harshan Radhakrishnan

**Vancouver Coastal Health**  
Emily Peterson

# Table of Contents

## S3-01 SECTION S3-01

### Introduction

01.1	Introduction	Page 05
	The Purpose of the Design Guide Supplement	Page 06
	Who Is This For?	Page 06

## S3-02 SECTION S3-02

### Risk and Resilience in Building Design

02.0	Resilience in Building Design	Page 08
	Designing for Comfort and Safety	Page 08
02.1	What is Overheating?	Page 09
02.2	What is Indoor Air Quality?	Page 11
02.3	A Balancing Act	Page 12

## S3-03 SECTION S3-03

### Modelling for a Future Climate

03.0	Modelling for a Future Climate	Page 14
03.1	Understanding Weather Data	Page 14
03.2	Performing a Future Climate Analysis	Page 15

## S3-04 SECTION S3-04

### Key Design Strategies

04.0	Key Design Strategies	Page 18
04.1	Passively Cool the Building	Page 19
04.2	Use Shading to Block Solar Heat Gains	Page 22
04.3	Cooling via Natural Ventilation	Page 25
04.4	Couple Passive Cooling with Active Approaches	Page 28
04.5	Add a Source of Cooling	Page 30
04.6	Filter the Air	Page 34
04.7	Include a Refuge Area into Building Design	Page 35

## A APPENDIX

### Resources

A1	Glossary of Terms	Page 38
A2	Image Sources	Page 40

SECTION S3-01.

# Introduction

- 01.1 Introduction
  - The Purpose of the Design Guide Supplement
  - Who Is This For?



## S3-01 Introduction

Buildings play a key role in preventing the adverse effects of climate change by employing design strategies to both reduce greenhouse gas (GHG) emissions and adapt to current and projected impacts.

To help reduce emissions from buildings, the Province of British Columbia has taken a number of actions. Under the umbrella of the CleanBC program, one such action is the release of the BC Energy Step Code, which sets energy performance requirements for new buildings as a means of reducing their energy use and emissions.

At the same time, the Province is projected to experience significant changes in climate over the next several decades, which will have considerable impacts on building performance. Preparing for Change: British Columbia's Adaptation Strategy, projects overall temperature increases of between 1.3 and 2.7°C by the year 2050, as well as heavier rains, longer dry spells, more heat waves and more severe wildfire events.<sup>1</sup> Such impacts can pose serious risks to British Columbia's buildings and the safety, well-being, and financial investments of their owners and occupants. Indeed, the average temperature across the province has already increased by 1.4°C over the last hundred years, with impacts on the built environment already occurring in different regions.<sup>1</sup>

Buildings can be designed to increase their resilience to these changes and in doing so, increase both their quality and overall value. Buildings constructed today should be designed in such a way that the comfort and safety of their occupants is ensured for the lifetime of the building. This is especially important as current building codes and standards are reflective of historical experiences – that is, they are based on past climatic conditions, and don't necessarily consider the impacts of a warmer world on the health, comfort, and safety of building occupants. Looking to future conditions is an increasingly important part of building design across all regions of the province.

<sup>1</sup> <https://www2.gov.bc.ca/gov/content/environment/climate-change/adaptation/impacts>

### Additional References



**Preparing for Climate Change: British Columbia's Adaptation Strategy**  
Province of British Columbia  
2010



**Special Report: Global Warming of 1.5°C**  
Intergovernmental Panel on Climate Change  
2018



**Resilience Planning New Construction**  
City of Toronto  
2017



**Climate Projections for Metro Vancouver**  
Metro Vancouver  
2016



**Climate Projections for the Capital Regional District**  
Capital Regional District  
2017



**Climate Projections for the Cowichan Valley Regional District**  
Cowichan Valley Regional District  
2017



**Moving Towards Climate Resilient Health Facilities for Vancouver Coastal Health**  
Lower Mainland Facilities Management  
2018



**BC Building Code – Appendix C**  
Province of British Columbia  
2018



**Update on Extreme Heat and Maximum Indoor Temperature Standard for Multi-unit Residential Buildings**  
Toronto Public Health  
2015



**Filtration in Institutional Settings During Wildfire Smoke Events**  
BC Centre for Disease Control  
2014

## The Purpose of the Design Guide Supplement

While potential climate change impacts on the built environment range by region and precise project location, this resource presents a set of design principles, strategies and practices intended to reduce the risk of two significant climate-related issues:

- 1**  
**Overheating**  
due to higher average temperature and increases in extreme temperature events (such as heat waves)
- 2**  
**Indoor air quality issues**  
due to an increase in wildfire events (as well as more localized sources of air pollutants)

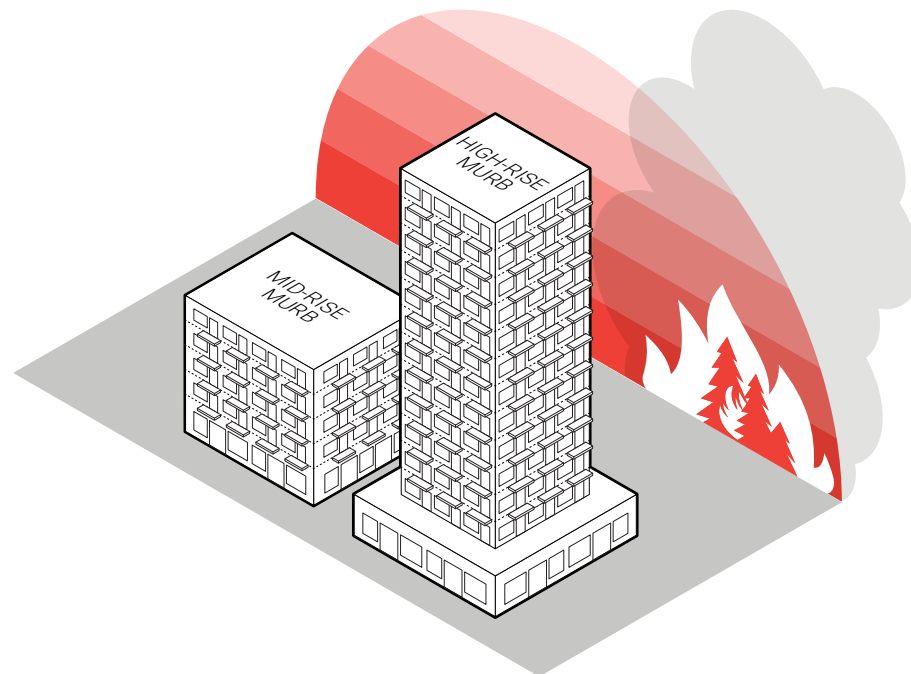

The information is intended primarily for Part 3 High-Rise and Mid-Rise Multi-Unit Residential Buildings (MURB) in British Columbia, and is most relevant for buildings constructed in Climate Zones 4 and 5. However, several of the strategies will also be useful and applicable to projects located in higher climate zones and to Part 9 MURB. While the information contained in this guide is relevant mainly to new buildings, many strategies can also be applied to renovations of existing buildings.

For those pursuing the BC Energy Step Code, the supplement is intended to complement the rest of the BC Energy Step Code Design Guide and should be referenced alongside it. However, the guide will serve as a useful resource for those working outside of British Columbia as well.

## Who Is This For?

This guide is a resource for local governments and design teams interested in pursuing the BC Energy Step Code.



### LOCAL GOVERNMENTS

Planners, urban designers, and other members of local government staff can play a role in supporting resilient buildings by encouraging the submission of applications that indicate how climate change adaptation strategies have been incorporated into building design. Local governments can use this guide as a means of understanding and promoting resilient building strategies.

### DESIGN TEAMS

Developers, architects, mechanical and building envelope engineers, and energy modellers all have a role to play in the design of safe, comfortable, and resilient buildings. Design teams that explore strategies to improve building resilience early on in the design process can more successfully identify ways to harness efficiencies and reduce overall costs. Teams should use this resource in conjunction with the rest of the BC Energy Step Code Design Guide to explore different design strategies for their potential to simultaneously improve energy efficiency, reduce GHG emissions, and improve overall building resilience.

SECTION S3-02.

# Risk and Resilience in Building Design

- 02.0 Resilience in Building Design  
Designing for Comfort and Safety
- 02.1 What is Overheating?
- 02.2 What is Indoor Air Quality?
- 02.3 A Balancing Act



## Resilience in Building Design

The idea of **resilience** refers to the ability of a system (such as a building) to anticipate, absorb, accommodate, or recover from the effects of an event or stress in a timely and efficient manner. The way in which a building adapts to an event (e.g. air quality advisory) or ongoing stress (e.g. elevated summer temperatures) depends on a number of factors, including its location, design, operations, and maintenance.

In general, a **resilient building** is one that is able to:

- 1** **Maintain critical operations and functions** in the face of either an acute shock or chronic stress, and return to normal operations in a fast and efficient manner, in order to maintain healthy, liveable spaces for its occupants.
- 2** **Improve the overall health and well-being** of its occupants through its design and operation.

## Key Terms

**PASSIVE SURVIVABILITY** is the extent of a building's ability to maintain healthy, liveable conditions in the event of extended loss of power or water, or in the event of extraordinary heat waves, storms or other extreme events.

**SHOCK** is an acute natural or human-made event or phenomenon threatening major loss of life, damage to assets and a building or community's ability to function and provide basic services (e.g. heat wave, wildfire).

**STRESS** is a chronic (i.e. ongoing or cyclical) natural or human-made event or phenomenon that renders a building or community less able to function and provide basic services (e.g. increased temperatures).

**THERMAL RESILIENCE** is the ability of a building to achieve thermal comfort in the event of power outages by improving weatherization and insulation, increasing air circulation, reducing solar gains through windows, increasing natural ventilation, and minimizing internal heat gains.

**VULNERABLE POPULATIONS** are groups and communities at a higher risk for poor health as a result of the barriers they experience to social, economic, political and environmental resources, as well as limitations due to illness or disability. These include children, pregnant women, elderly people, people with low incomes, and people who are ill or immunocompromised.

## Designing for Comfort and Safety

Designing for the most vulnerable occupants of a building can be a way to ensure that all occupants remain comfortable and healthy. This approach should be used by carefully considering the building's expected occupancy, and identifying strategies that benefit all occupants.

Resilient building design involves the need to maintain overall health and well-being of all building occupants. Designed, constructed, and managed thoughtfully, a resilient building can actually improve its core functions over the business-as-usual, and offer a safer, more comfortable alternative for both its occupants and the broader community.

For example, a highly resilient building can act as a refuge centre for a block or neighbourhood during extreme events by providing access to communal spaces with power, cooling, and good ventilation. Such centres can provide important resources during a range of extreme events, from heat waves to extreme storms and earthquakes.

- 1** Occupants with respiratory issues
- 2** Pregnant occupants and unborn children
- 3** Elderly occupants
- 4** Infants and young children

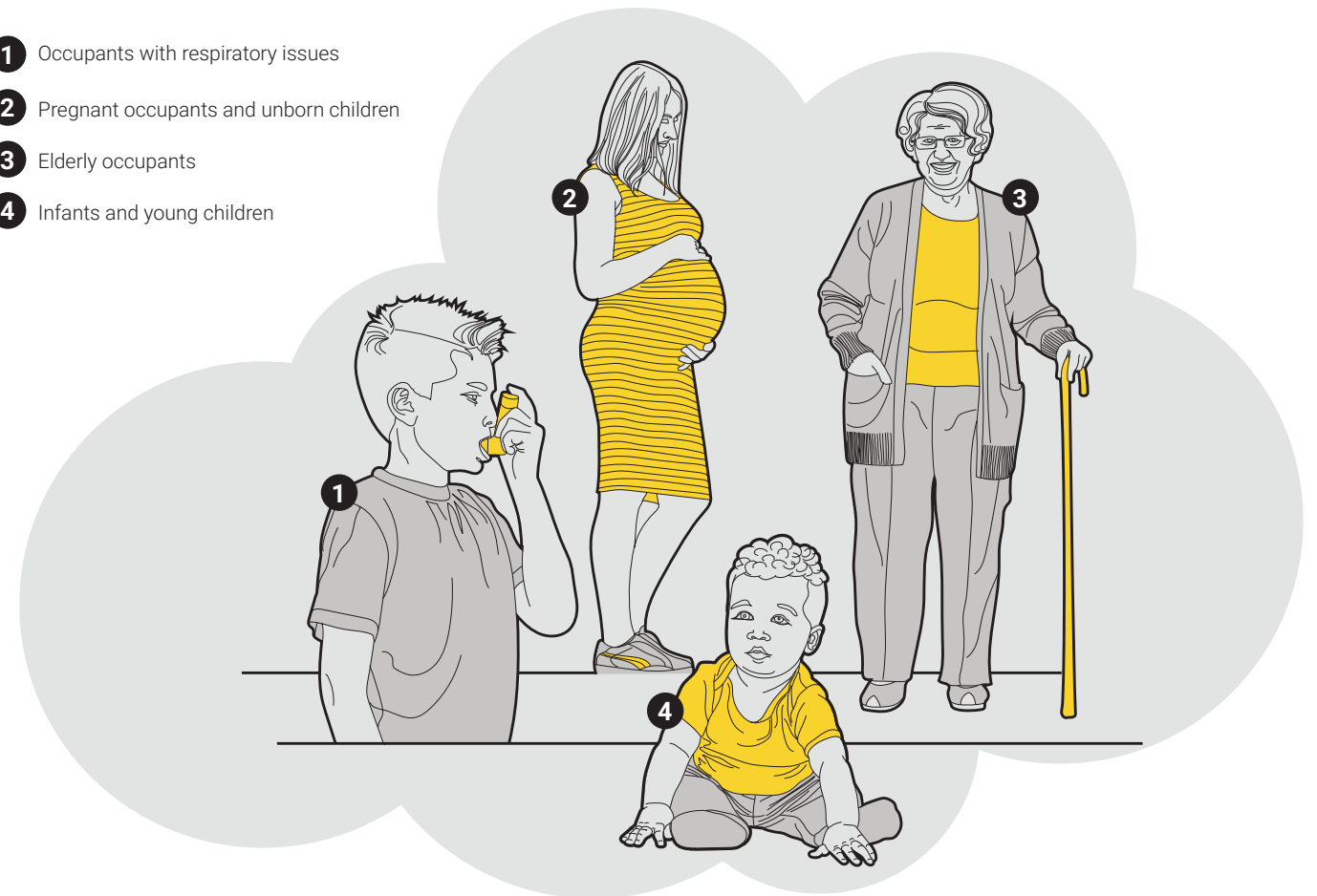



## 02.1 What is Overheating?

Overheating occurs when a space becomes too warm for its occupants. Prolonged or dangerously high temperatures can cause health risks, such as heat stress, heatstroke, increased morbidity or even mortality, particularly in vulnerable populations. Indeed, exposure to indoor temperatures above 26°C has been associated with increased premature mortality and emergency medical services calls<sup>2,3</sup>.

### Overheating vs. Thermal Comfort

Related to the concept of overheating is **thermal comfort**, which is achieved when an occupant is satisfied with the temperature in a particular space. Individuals' experience of thermal comfort is complex, highly subjective and can depend on:

- 1 **Individual characteristics**  
(e.g. age, metabolic rate, size, overall health, preference)
- 2 **Behavioural factors**  
(e.g. whether a person is at rest, sitting, walking, or exercising)
- 3 **Cultural norms**  
(e.g. type of attire worn)
- 4 **Physical considerations**  
(e.g. air and radiant temperatures, air speed and relative humidity)

### Designing for Thermal Comfort

While experiences of thermal comfort can vary, ASHRAE Standard 55 – Thermal Environmental Conditions for Human Occupancy is a research-based standard that outlines specific methodologies to predict and measure occupant thermal comfort for healthy adults.

ASHRAE Standard 55 generally recommends occupied spaces to be designed to stay below 24-25°C (dry bulb) in the winter and 27-28°C (dry bulb) in the summer to prevent overheating. However, this can vary based on the intended use of the space, as well as other factors. For example, young children may not be able to cope with higher temperatures.

While it may not pose health risks for everyone, the experience of thermal discomfort can impact quality of life.

For instance, occupants may not be able to use building spaces as they were designed to (e.g. a bedroom may be too warm to sleep in). Occupants may leave a building altogether if it becomes uncomfortably hot, interrupting their ability to live and work normally.

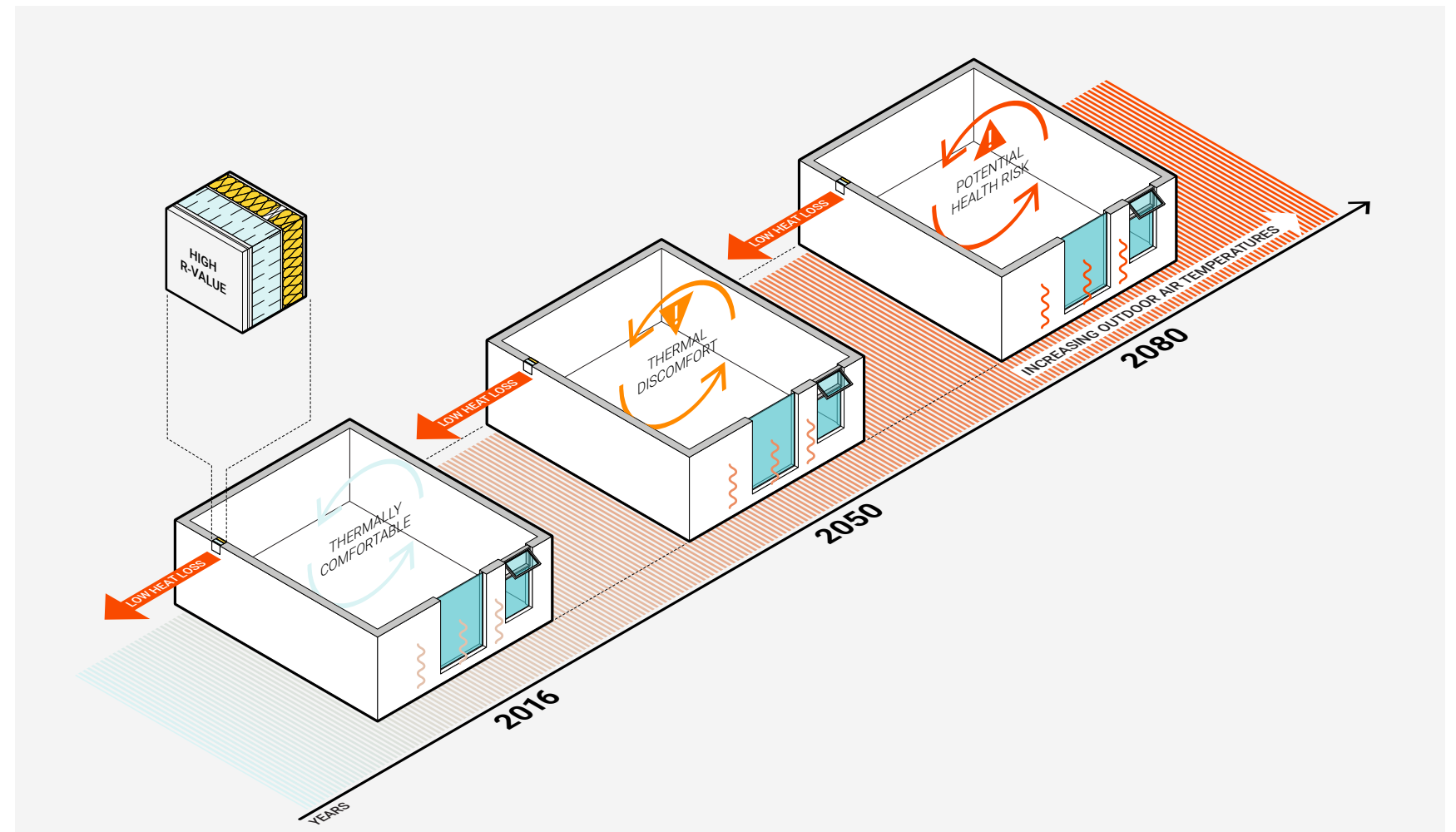

### Comfort Today Can Be Discomfort Tomorrow

In 2009, British Columbia experienced a heat wave that contributed to an additional 110 overheating-related deaths per week<sup>4</sup>.

Globally, the five hottest years have all occurred since that year<sup>5</sup>, and even warmer temperatures are anticipated in the future.

As temperatures continue to increase, so too will the likelihood and magnitude of overheating in our buildings. Spaces that are designed to be comfortable today are likely to become uncomfortable under future climate conditions if care isn't taken to consider increasing temperatures. Energy efficient buildings can be especially at risk of overheating, as higher

performance building envelopes can retain more heat in the summer.

Overall, designers will need to provide an adequate source of cooling using both passive and active building strategies to maintain the comfort and livability of our buildings.

<sup>2</sup> <https://www.toronto.ca/legdocs/mmis/2015/hl/bgrd/backgroundfile-85835.pdf>

<sup>3</sup> <https://www.tandfonline.com/doi/pdf/10.1080/23328940.2018.1456257>

<sup>4</sup> <https://www.cbc.ca/news/canada/british-columbia/heat-warning-change-environment-canada-1.4762636>

<sup>5</sup> <http://www.climatecentral.org/gallery/graphics/the-10-hottest-global-years-on-record>

### Factors Involved in Overheating

Overheating can be caused by a combination of physical, behavioural and climatic factors.

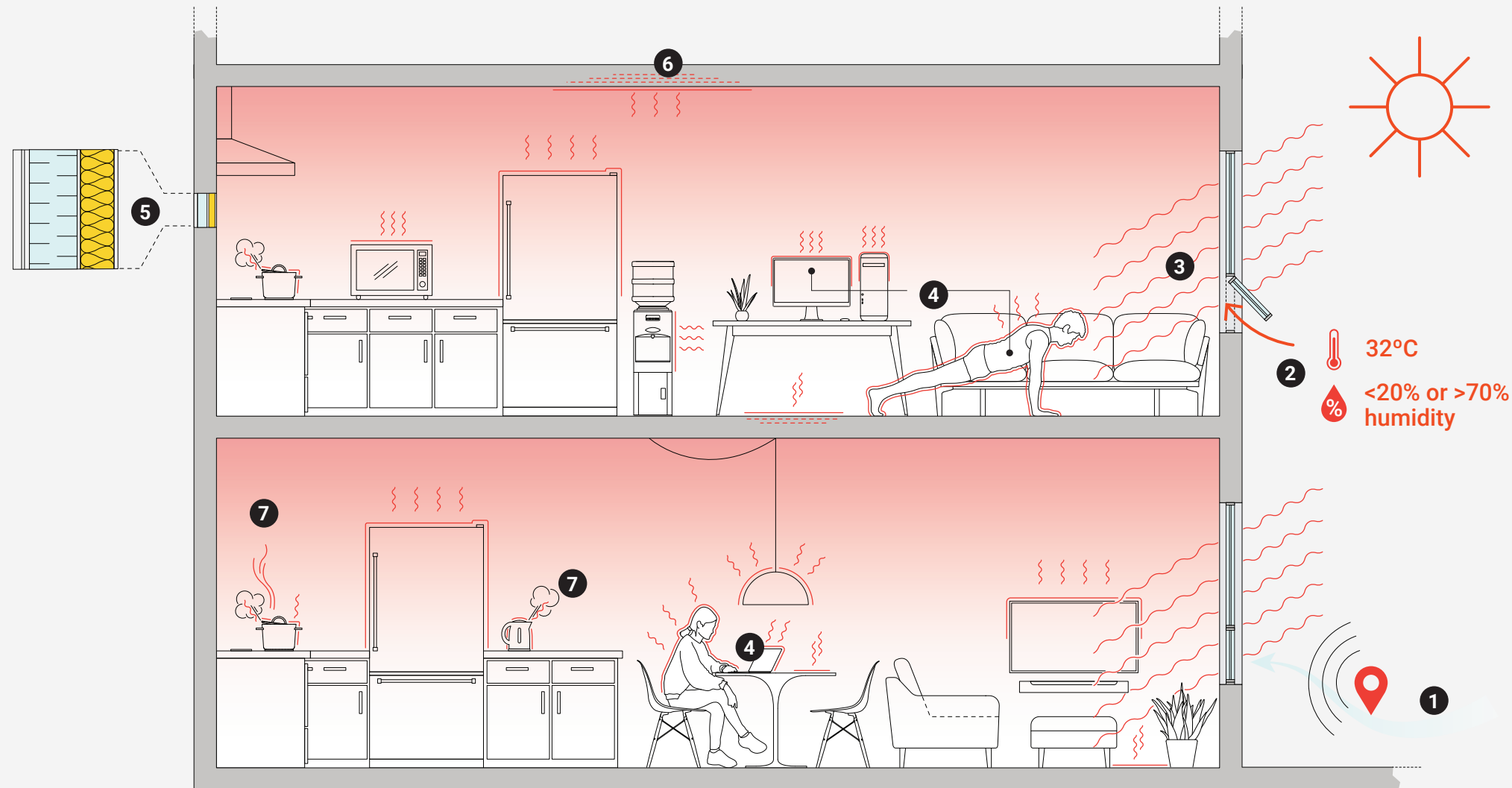

- 1** Contextual or situational factors that prevent occupants from opening their windows (e.g. noise, pollution, poor outdoor air quality)
- 2** High external temperatures and/or extreme humidity levels
- 3** Internal heat gains via incoming solar radiation through the building glazing
- 4** Internal heat gains from lighting, equipment, occupants and occupant activities
- 5** High wall and roof insulation and/or building airtightness that retain internal heat gains
- 6** Absorption of heat by the buildings structure that create high surface temperatures
- 7** Lack of adequate ventilation that could assist in cooling

### Limiting Overheating

Both the BC Energy Step Code (BCESC) and the City of Vancouver Zero Emissions Building Plan (ZEBP) set limits for overheating.

For spaces that do not use any mechanical cooling, temperatures cannot exceed “80% acceptability limits” for more than **200 hours** during the summer months. The 80% acceptability limit is a specific temperature during the summer months at which overheating can be a concern, which varies depending on the building’s location. This limit is calculated using a methodology defined in ASHRAE Standard 55. A full definition can be found in the City of Vancouver Energy Modelling Guidelines v2.0. It is important to note that buildings that house vulnerable populations have a lower limit of **20 hours**, but owners and project teams may target a lower number to limit the risk of overheating for project type.

For spaces that make use of mechanical cooling, design teams must demonstrate that each space will experience less than 100 “unmet cooling hours” per year. Unmet cooling hours occur when a cooling system is unable to achieve the desired indoor temperature. A full definition of unmet cooling hours can be found in NECB 2015 – Section 8.4.1.2 Determination of Compliance.

### International Guidance

The Chartered Institution of Building Services Engineers (CIBSE, similar to ASHRAE in the United Kingdom) provides tools to reduce the risk of overheating through Technical Memoranda TM52 and TM59. These set a 3% limit on the number of hours that a space’s indoor temperature can exceed the threshold comfort temperature by 1°C or more during the occupied hours of a typical non-heating season. Overheating limits are also set for the severity of overheating on a given day (i.e. the number of hours), as well as an absolute maximum daily temperature for each room. For example, **bedrooms cannot exceed an operative temperature of 26°C for >1% annual night-time hours, between the hours of 22:00 and 07:00.**

## 02.2 What is Indoor Air Quality?

Indoor air quality is an important determinant of the health of building occupants and is affected by both indoor and outdoor factors.

### BC Air Quality Projections

Climate change projections for BC include an increase in the number of wildfire smoke events. This smoke contains a mixture of fine particulate matter, carbon monoxide, nitrogen oxides, volatile organic compounds, and heavy metals. Studies also predict increased levels of ozone in the summer months. While ozone in the stratosphere plays a beneficial role in offering protection from the sun's ultraviolet rays, ozone near the ground contributes to the formation of urban smog and is harmful to breathe.

Exposure to air contaminants have been linked to several short- and long-term health effects, including:

- Fatigue
- Headaches
- Eye/nose/throat irritation
- Impaired cognitive function/decline
- Respiratory diseases
- Cardiovascular disease
- Diabetes and obesity
- Cancer

### Air Quality Standards

The BC Building Code (BCBC) recognizes that outdoor air may not always be of an acceptable quality for ventilating buildings unless certain particles and gases are first removed or reduced. Code requirements for indoor air quality are outlined in the BCBC and ASHRAE 62.1, and set minimum ventilation requirements to maintain CO<sub>2</sub> concentrations below a certain threshold.

Developers interested in pursuing higher air quality standards can find examples in the Leadership in Energy and Environmental Design (LEED) standard and the WELL Building Standard™, both of which define thresholds for various pollutants. These standards require verification to demonstrate compliance with their set thresholds, and assess the effectiveness of ventilation systems to verify that a sufficient level of ventilation is provided.

### Factors Involved in Poor Indoor Air Quality

1

**Indoor sources of contaminants** include cleaning products, off-gassing from building materials and furnishings, cooking, and parkade exhaust, among others. High noise levels outside may also force occupants to close their windows, increasing the risk of poor indoor air quality.



2

**Outdoor sources of contaminants** that vary depending on local context, and include traffic, industry, construction, and hazmat emergencies involving flammable or poisonous substances.



3

**Outdoor sources of contaminants** that affect entire regions, including urban smog due to increased ground-level ozone, and wildfire smoke events that will increase in frequency and severity with climate change.

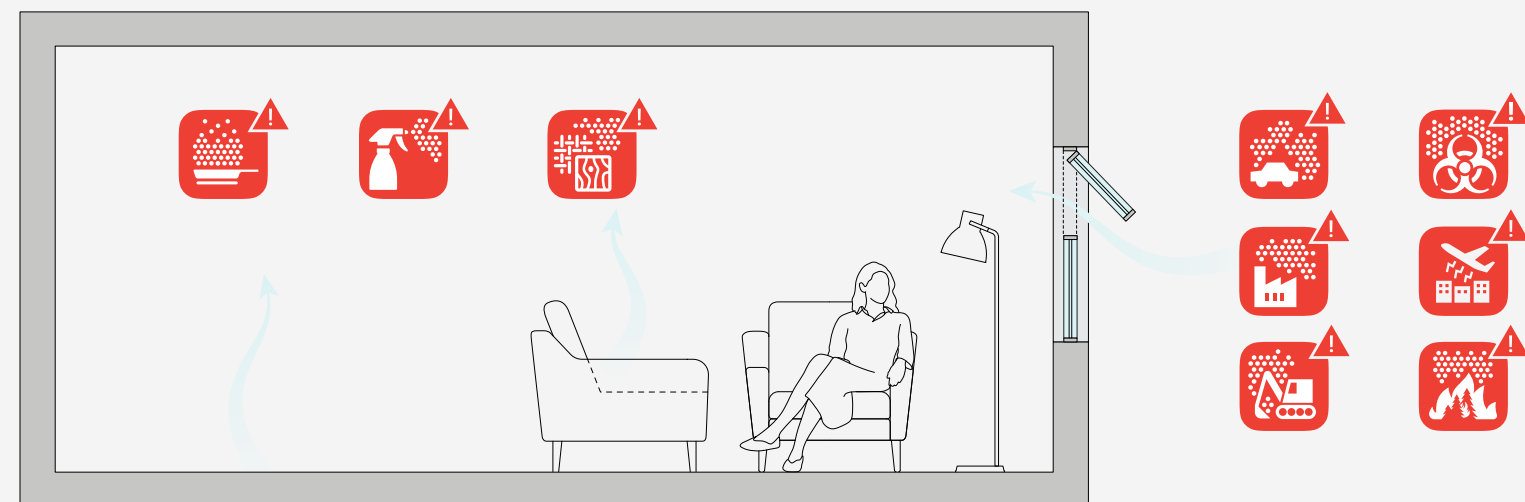

## 02.3 A Balancing Act

Design strategies that minimize overheating and indoor air quality issues can impact a building’s chances of achieving the targets of either the BC Energy Step Code and/or the City of Vancouver’s Zero Emissions Building Plan. It is therefore important to understand the relationship between these targets.

### Total Energy Use Intensity (TEUI)

Passive cooling strategies, such as operable windows, help to reduce a building’s TEUI. However, they can be unsuitable under conditions of poor exterior air quality, as they let in unfiltered air. Using mechanical cooling to keep a space comfortable in the summer can help to prevent poor outdoor air quality from entering the building, especially when some degree of filtration is added.

### Thermal Energy Demand Intensity (TEDI)

A high-performance building envelope will lead to better TEDI performance and can slow the movement of summer heat into the building. However, it can also lead to overheating issues when internal gains are trapped inside during the summer months. Passive cooling strategies designed to reduce overheating can also result in an increase in a building’s overall TEDI in the winter by reducing passive solar gains.



### Airtightness (AT)

Improved airtightness leads to better TEDI performance and reduces the risk of indoor air quality issues from outdoor sources. A more airtight building envelope is highly effective in reducing winter heat loss. However, a less airtight building will not help to dissipate summer heat, making airtightness an important consideration for all building designs.



### City of Vancouver ZEBP Greenhouse Gas Intensity (GHGI)

Depending on the system that is used, mechanical cooling can increase both the TEUI and the GHGI of a building. Using heat pumps for both heating and cooling can reduce a building’s GHG emissions when compared to a natural gas-based or lower-efficiency electric heating system.



**1**  
**Exterior shading** can be an effective strategy for reducing risk of overheating. However, it can also block desired passive solar heating in winter if not carefully designed, increasing TEDI.

Lower risk of OVERHEATING  
  
Higher TEDI  





**2**  
**Operable windows** allow occupants to passively cool their space. In some situations, this unfiltered air may have an adverse effect on indoor air quality.

Lower risk of OVERHEATING  
  
Higher risk of POOR IAQ  

**3**  
**Low solar heat gain glazing** can reduce the risk of overheating. As with shading, however, this may also block desired passive solar heating in winter, increasing TEDI.

Lower risk of OVERHEATING  
  
Higher TEDI  

**4**  
**Mechanical cooling** can eliminate any overheating issues, but at the expense of increased energy use, increasing TEUI. This can also help with indoor environmental quality since it can allow the occupant to keep windows closed, keeping both noise and contaminated outdoor air out.

Lower risk of OVERHEATING  
  
Higher TEUI  
  
Lower risk of POOR IAQ  

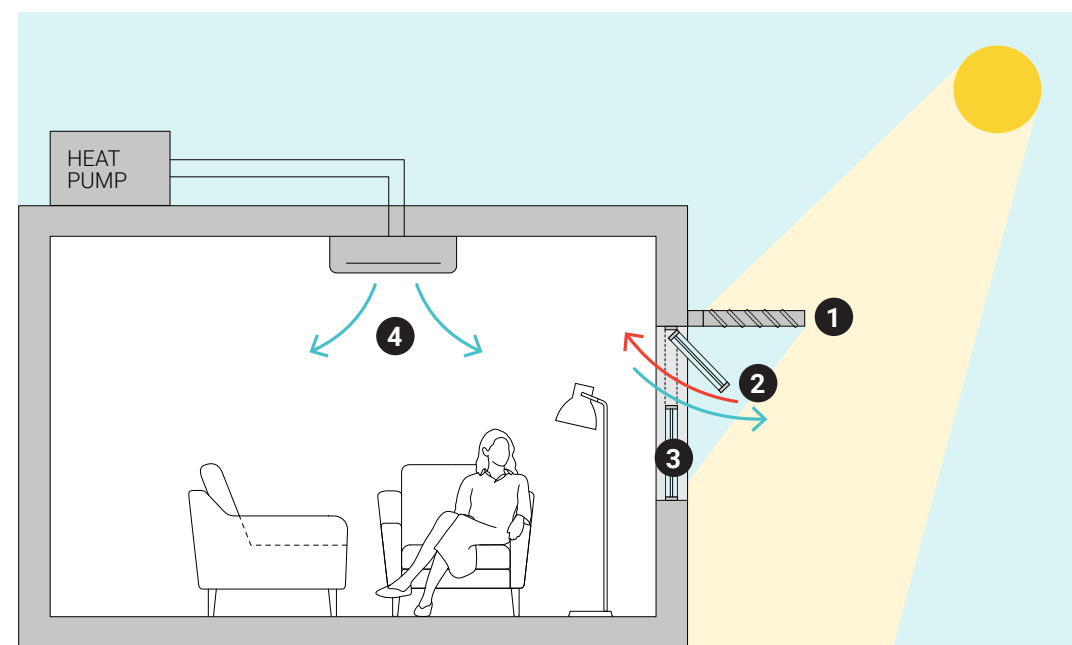

**THE RIGHT TOOLS FOR THE JOB**

Proper evaluation of strategies such as exterior shading and operable windows can be complex and require the use of powerful simulation tools. Ensure your team has the right tools to provide good quality information for making decisions.

**KEY TAKEAWAY**

Consider the impacts of design strategies used to achieve energy efficiency or emissions reductions on occupants’ thermal comfort and indoor air quality.

SECTION S3-03.

# Modelling for a Future Climate

- 03.0 Modelling for a Future Climate
- 03.1 Understanding Weather Data
- 03.2 Performing a Future Climate Analysis



## 03.0 Modelling for a Future Climate

One of the key ways that design teams can explore a building’s potential for overheating is by using an energy model.

Energy models are used to assess the impact of a building’s design on occupants’ comfort by simulating building performance using different assumptions, including assumptions around the weather. However, standard approaches to energy modelling use weather files that are based on 30 years of historical data – in other words, the climate of the past. Since the climate has continued to warm and change, these weather files are unable to accurately represent current conditions, let alone future conditions.

Adopting an approach to energy modelling that takes future climate conditions into account can help design teams and owners make decisions today that will last the life of the building. This is particularly important given that occupants will be using these buildings for the next 50 years, if not more.

### 03.1 Understanding Weather Data

To model for a future climate, energy modellers need future climatic data. These data come in different formats, and often have different intended uses.

**Energy Simulation Weather Files** are used in energy models to help simulate the performance of a building over the course of a year.

Canadian Weather Year for Energy Calculation (CWEC) files are used to represent a “typical” year of weather data. These files are generated by Environment Canada for a specific location based on 30 years of historical weather data using the most typical results for each month of the year. The original CWEC files used data from 1959 to 1989, but were updated in 2016 to reflect 1984 through 2014.

**Design Data** represent peak conditions for a location and are used for sizing mechanical heating and cooling equipment. These data are provided in the National Building Code, BC Building Code and Vancouver Building Bylaw.

Design data use near-worst case winter and summer temperatures, which are based on weather observations collected from 1981 to 2006 by the Atmospheric Environment Service at Environment Canada.

- For summer, mechanical cooling systems are typically designed to the July 2.5% temperature – in other words, only 2.5% hours per year are expected to increase above this temperature.
- For winter, heating equipment is typically designed to the January 1% temperature – in other words, only 1% hours per year are expected to go below this temperature.

A Common Example of Weather File Used in Energy Simulation

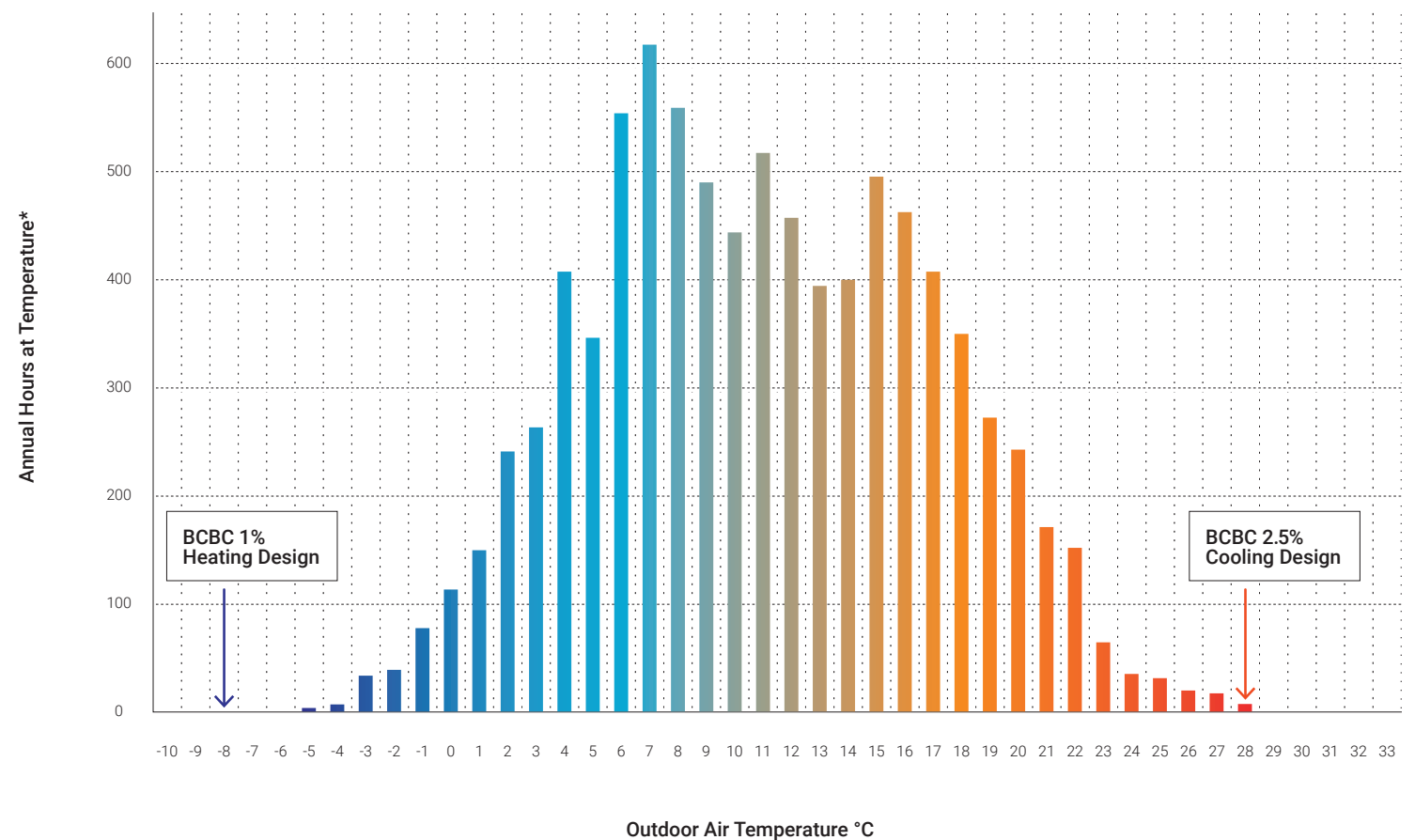

\* Typical Number of Hours Based on 30 Years of Historical Weather Data (1984 -2014) Published in CWEC 2016.

An energy simulation weather file will contain temperature data for all 8760 hours of the year for a given location, while design data only represent the hottest and coldest conditions for mechanical equipment sizing.

## 03.2 Performing a Future Climate Analysis

Design teams can conduct future climate analysis using available data on future weather projections and climate scenarios. Running multiple time periods and climate scenarios can help to give owners and design teams a better understanding of the potential impact of different design decisions.

**Weather file projections** are most often developed for the 2020s, 2050s and 2080s.

**Climate scenarios** are usually presented using three possible futures, or "Representative Concentration Pathways" that indicate the degree of climate change severity that we are likely to experience:

- The **Best-Case Scenario (RCP 2.6)** assumes that we will drastically reduce our GHG emissions and begin to remove existing GHGs from the atmosphere.
- The **Stabilization Scenario (RCP 4.5)** assumes that all countries will undertake measures to mitigate emissions simultaneously and effectively.
- The **Worst-Case Scenario (RCP 8.5)** assumes that we will experience high population growth and relatively slow income growth with modest rates of technological change and energy intensity improvements.

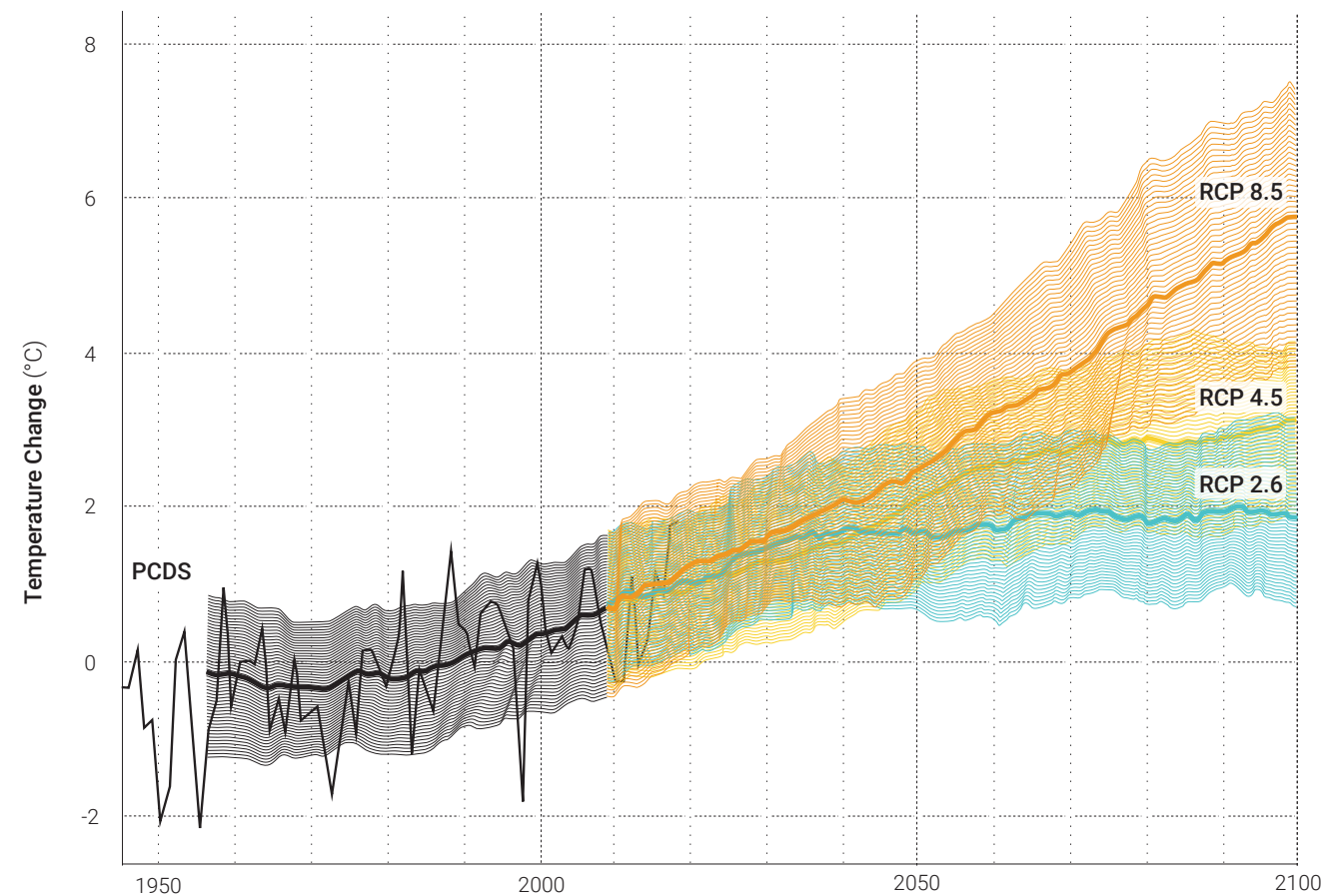

Adapted from Figure SPM.7a from "Summary for Policymakers" by Climate Change 2013: The Physical Science Basis. Lighter colour bands represent the range of potential temperature increases within a single scenario.

### Sources of Future Weather Files

#### CLIMATEDATA.CA

Launched by the Government of Canada in July 2019, this site allows users to search for climate data by location, view interactive climate data maps with detailed time series graphs, and download datasets.

#### WEATHERSHIFT.COM

This site provides simple future weather projections for major Canadian cities and allows weather files to be uploaded and translated into future scenarios for a fee.

#### PACIFIC CLIMATE IMPACTS CONSORTIUM

PCIC is a leading organization researching climate change and its impact to Canada's western regions. Their website provides access to a variety of practical tools and sources of climate information.

### KEY TAKEAWAY

Even with ongoing efforts to reduce our carbon emissions, changes in climate to 2050 are guaranteed due to the inertia in the climate system. At a minimum, building designers should consider a 2050 climate scenario of RCP 8.5. Even if the climate begins to stabilize before 2050, this will improve resilience for the lifespan of the building.

### Case Study: A Future Climate Analysis for a Mixed-Use Residential Building

A climate weather analysis was completed on a mixed-use residential and clinic facility in Vancouver to better understand the design strategies a specific project might need to reduce overheating. The analysis compared the risk of overheating using CWEC 2016 data to the risk that might occur in 2050.

The study explored operable windows as a way of reducing the total number of overheating hours. Under a CWEC 2016 climate, the model showed that operable windows reduce overheating hours from 2271 to 29, making them a good passive cooling strategy.

However, the warmer temperatures of the 2050s make operable windows far less effective, pushing overheating hours above the BC Energy Step Code’s allowable limit of 200 hours for the general population, and 20 hours for vulnerable populations. The results of this study show that additional strategies are necessary to cool the building.

To explore additional methods of passively cooling the building, a second analysis explored the effectiveness of shading for the hottest rooms in the building.

The study found that for these rooms, peak indoor temperatures can coincide with peak outdoor temperatures, and not the peak intensity of incoming solar gains. As such, adding shading will not be sufficient in preventing overheating. As peak outdoor summer temperatures in the 2050s near 34°C, indoor temperatures in these suites will exceed the target indoor temperature of 28°C set by ASHRAE 55.

The results of these modelling exercises show that adding some form of mechanical cooling will be necessary to avoid overheating in the 2050s.

However, the addition of mechanical cooling in this analysis cause a spike in the building’s Total Energy Use Intensity (TEUI). This means that the project’s design team will have to incorporate additional energy saving features in order to meet both its TEUI and overheating targets.

Average Suite Summer Overheating Hours  
Operable versus Fixed Windows

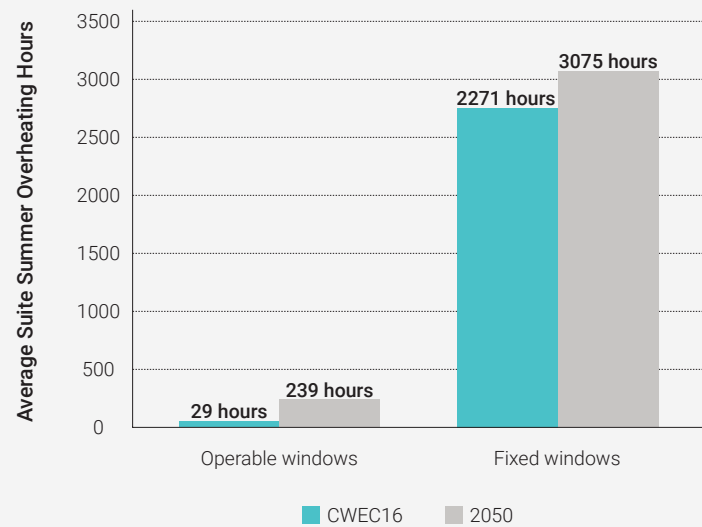

**METRIC:** BCESC Overheating Hours  
**PROJECT TARGET:** < 200 hours, per BCESC  
**CWEC 2016 RESULT:** 29 hours  
**2050 RESULT:** 239 hours

Level 6 SW Corner Suite Indoor and Outdoor Temperature  
and Solar Radiation; July 23, 2050s

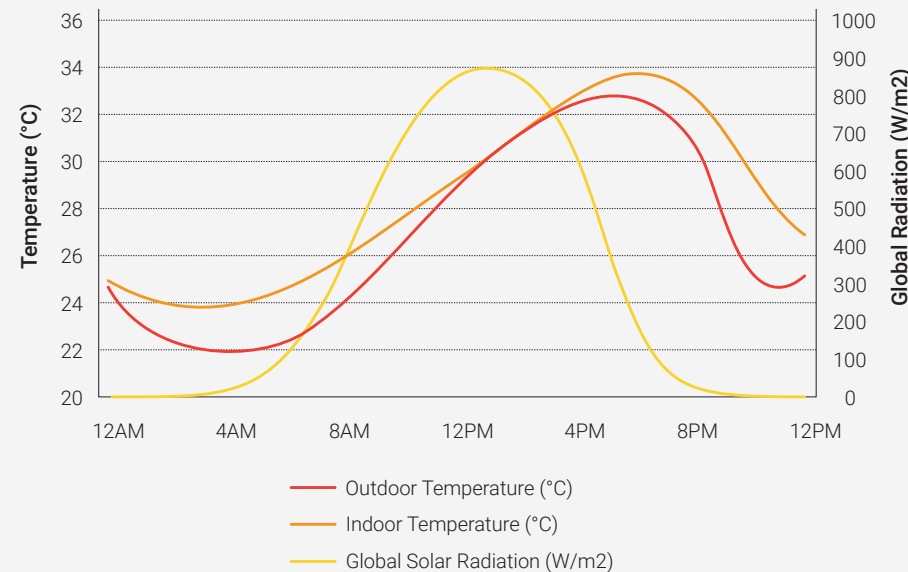

**METRIC:** Peak Temperature in Southwest Suite  
**PROJECT TARGET:** < 28°C, per ASHRAE 55  
**2050S RESULT:** 34°C

Energy End Use Intensity Breakdown  
Highlighting Cooling and Heat Rejection

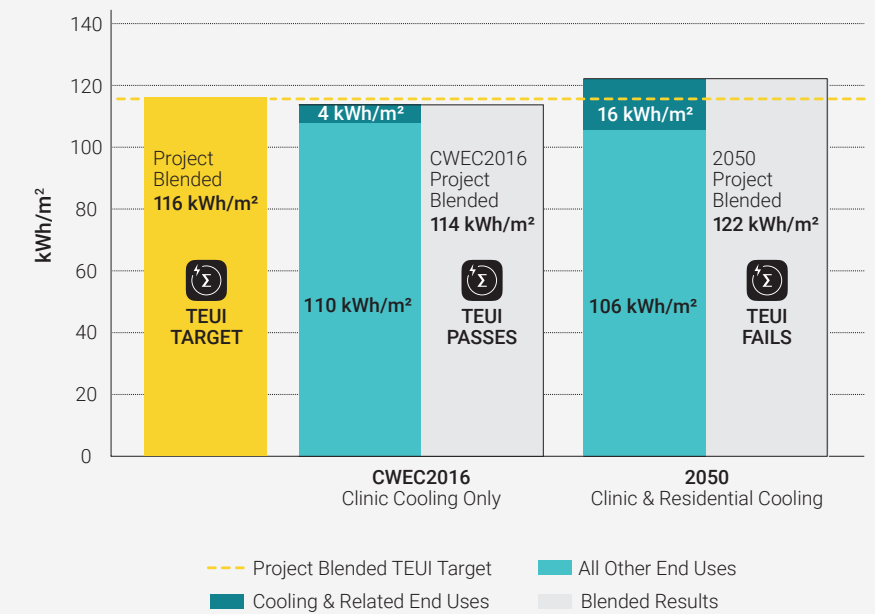

**METRIC:** BCESC TEUI  
**PROJECT TARGET:** 116 kWh/m²  
**2016 RESULT (NO COOLING):** 114 kWh/m²  
**2050 RESULT (WITH COOLING):** 122 kWh/m²



SECTION 04.

# Key Design Strategies

- 04.0 Key Design Strategies
- 04.1 Passively Cool the Building
- 04.2 Use Shading to Block Solar Heat Gains
- 04.3 Cooling via Natural Ventilation
- 04.4 Couple Passive Cooling with Active Approaches
- 04.5 Add a Source of Cooling
- 04.6 Filter the Air
- 04.7 Include a Refuge Area into Building Design



## 04.0 Key Design Strategies

This section presents details on the key design strategies necessary to mitigate air quality and overheating issues in MURB.

### High-Rise MURB

In this guide, High-Rise MURB refers to multi-unit residential buildings of six storeys or higher, often designed and built using concrete construction techniques. Such buildings usually consist of one to two storeys of commercial space at grade, with up to several dozen setback storeys of residential units above. Exclusively residential high-rise MURBs often include common areas (e.g. lobbies) and shared-use facilities (e.g. gyms and common rooms), alongside or in addition to ground-level suites.

### Mid-Rise MURB

Mid-Rise MURB refers to multi-unit residential buildings of three to six storeys, and designed and built using wood-frame construction techniques. Mid-rise MURBs can be configured with a concrete first storey and wood construction above. Mid-rise MURBs can be residential only, or else host small businesses in the first and second storeys.

### Key Design Strategies

The strategies presented in this section represent some of the most effective strategies to reduce the risk of indoor air quality and overheating issues that can be applied in BC's Climate Zones 4 and 5. Lower Mainland (Climate Zone 4). However, site conditions, the owners' performance requirements, and many other factors will affect what strategies are most appropriate for a given project. As such, designers should consider a variety of strategies to determine the best response to meet their specific needs.

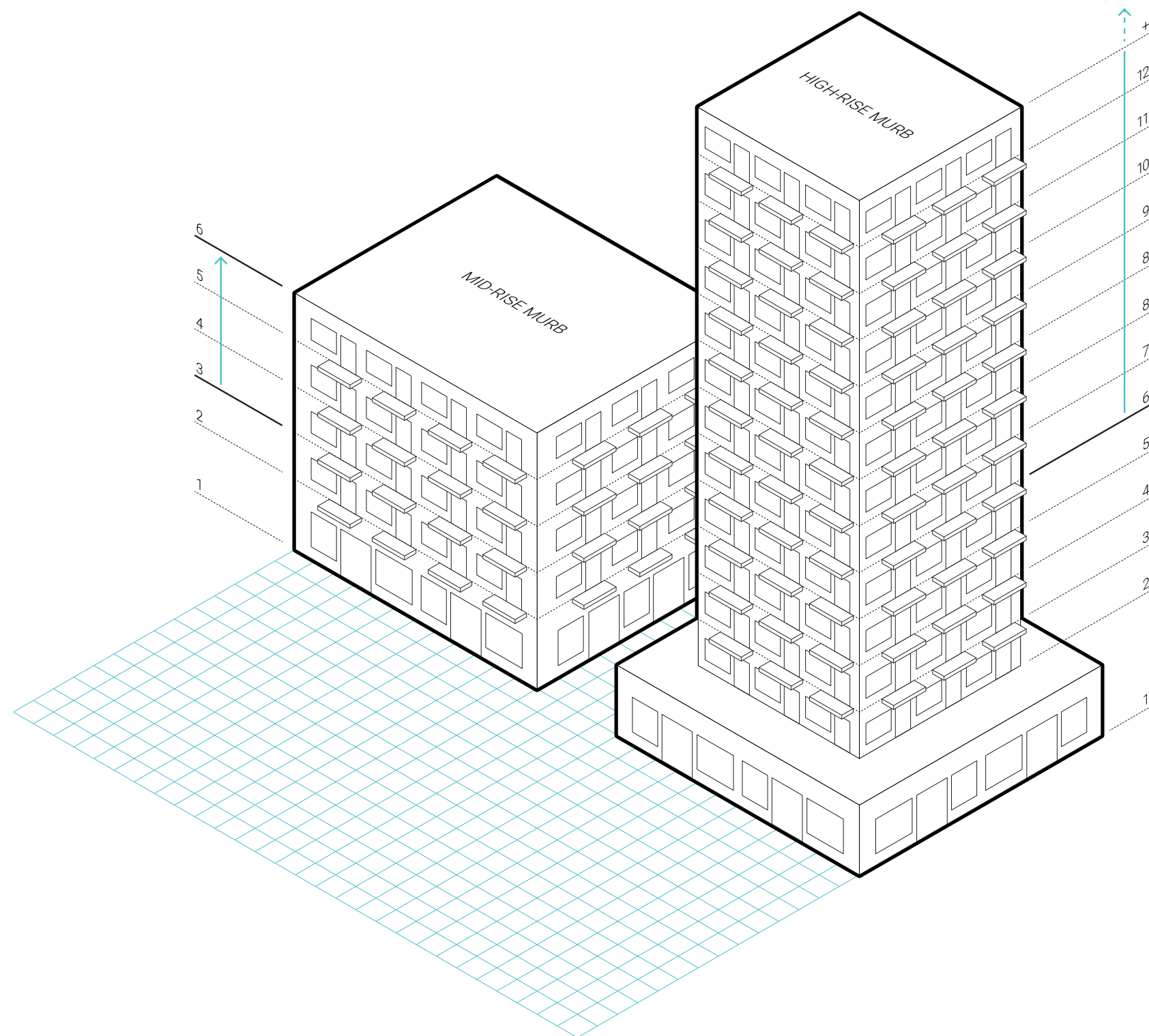

## 04.1 Passively Cool the Building

The use of passive cooling strategies is an important way to either reduce or remove heat from a space without increasing the building’s overall energy use.

Some passive strategies can be applied across an entire building’s design and should be considered in early stages of the design process for greatest impact, while others (such as adding vegetation) can be added later on. Additional details on using passive design to increase energy efficiency can be found in the main body of the BC Energy Step Code Design Guide.

### Building Shape and Massing

A simple shape and compact massing can help reduce heat losses in the winter. However, complex massing may provide better access to passive cooling strategies, such as operable windows and self-shading from solar gains. Designers should explore means of maximizing building energy efficiency through shape and massing, while considering the potential benefits of a particular geometry to mitigate overheating.

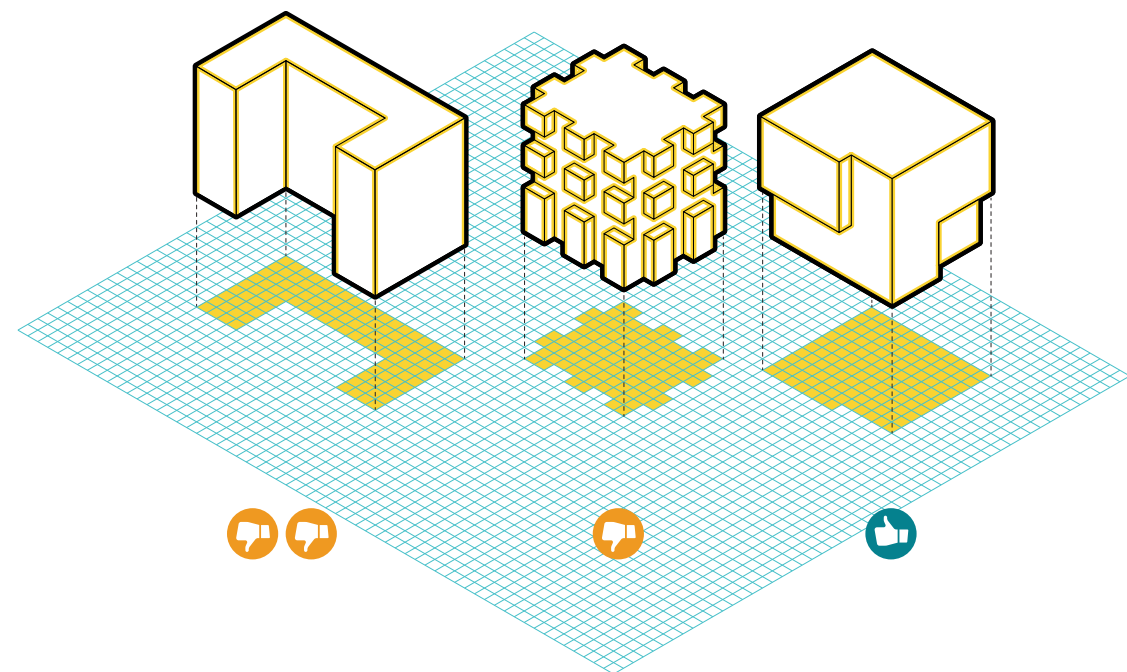

### Building Orientation

While a building’s orientation is often determined by the site’s size, shape and general constraints, orientation can be optimized to balance energy performance and overheating.

Building orientation should maximize the south and north facades and minimize the east and west facades. Windows and effective shading can then be optimized on south and north facades to maximize solar gains for “free heating” in the winter, while blocking gains in the summer.

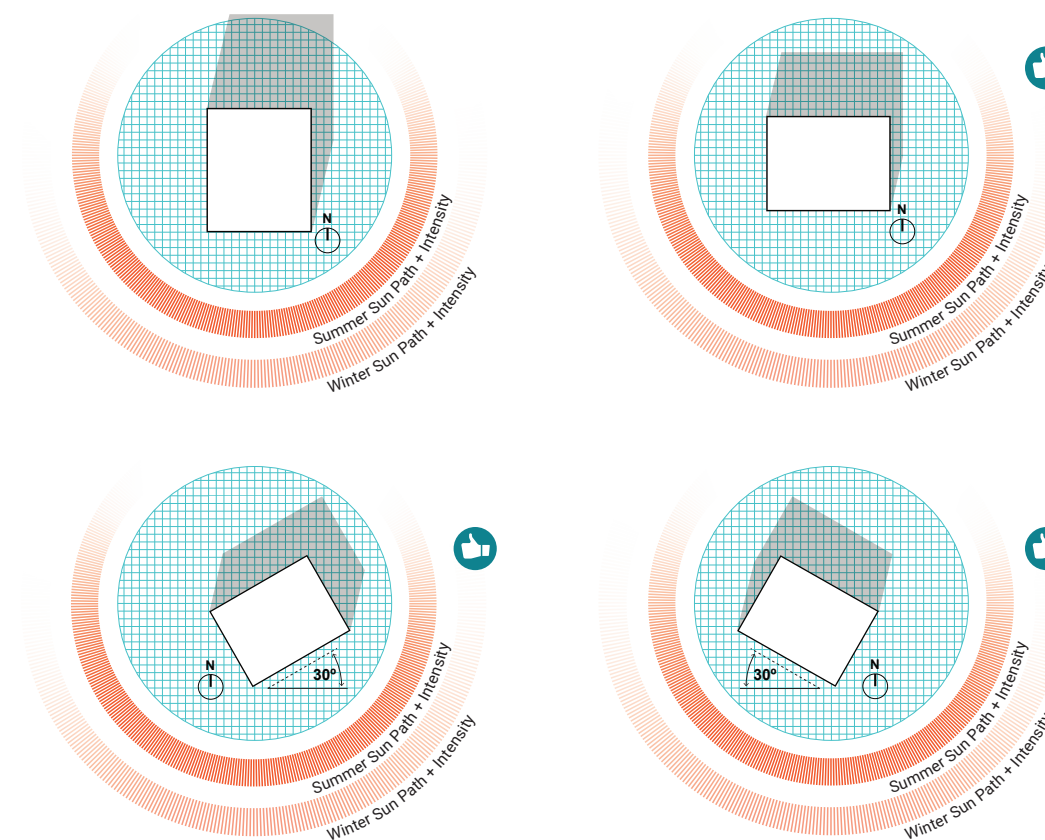

### Thermal Mass

Thermal mass refers to a material's ability to absorb and store heat. Buildings with high thermal mass can absorb and store heat during the day when temperatures are high, reducing cooling energy requirements. This heat is then released at night when temperatures are cooler, and can be removed using passive strategies such as operable window or vents.

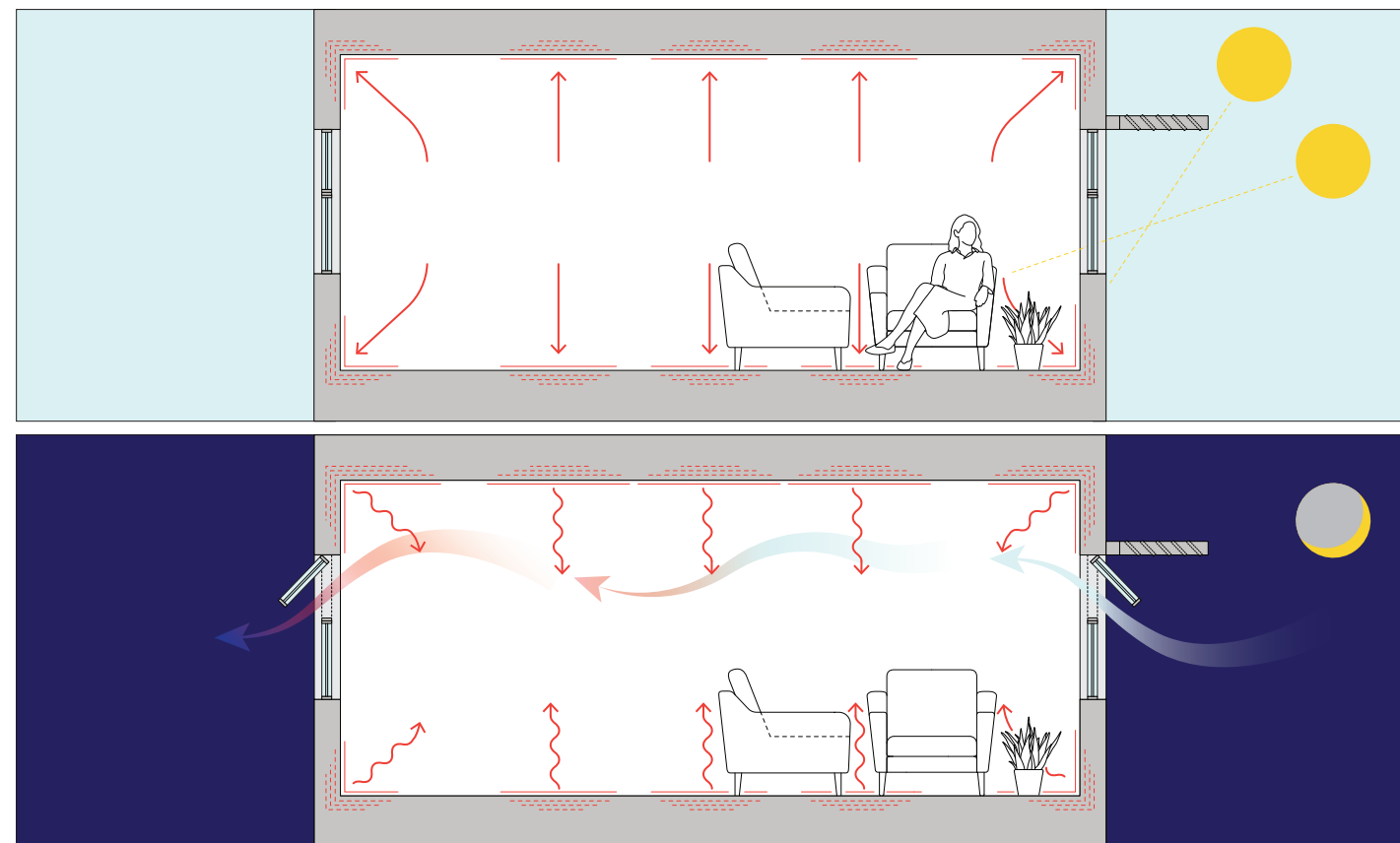

### Window Design

Lower window-to-wall ratios can reduce solar gains in the summer while also reducing heating energy requirements in the winter. To maximize control over heat gains, south and north facades should have higher window-to-wall ratios than on the east and west facades.

While higher U-values help reduce winter heat losses, they can also retain heat in the summer, and should be used in combination with other passive cooling strategies.

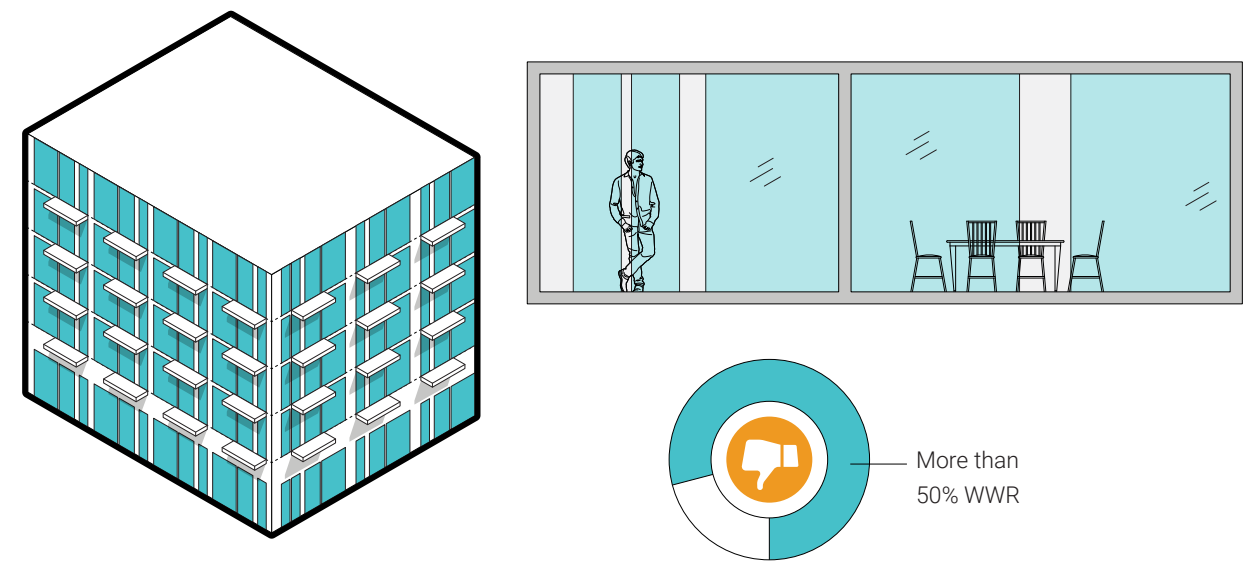

#### KEY TAKEAWAY

Consider building-level passive cooling strategies early on in the design process to minimize overheating in passively-cooled buildings, and reduce overall energy consumption in mechanically-cooled buildings.

### Cool Roofs

Roofs that are designed to reflect solar gains can help reduce the amount of heat let into the space, particularly in buildings that have a higher roof-to-floor area ratio. Designers should consider using reflective materials and colours, proper insulation (to reduce downward heat transfer), and green roofs with planted materials that absorb solar radiation. Cool roofs have the added benefit of reducing local heat island effect and reducing the overheating potential for both the building and its surrounding neighbourhood.

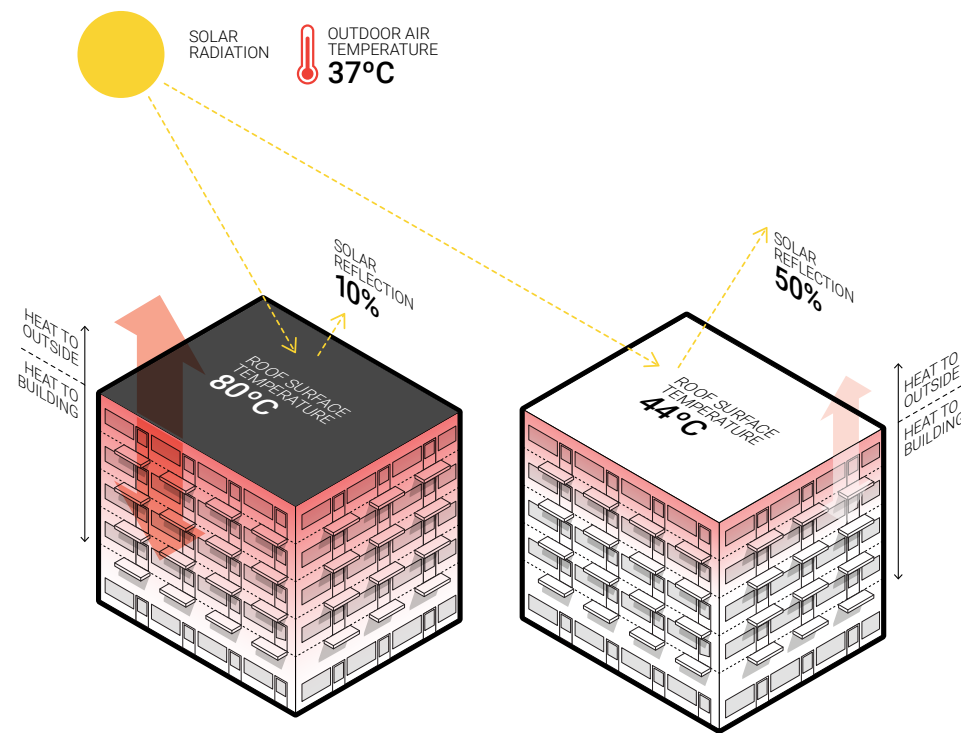

### CASE STUDIES

#### The Impact of Orientation on Overheating

Credit: BC Housing and Horizon North Manufacturing

To assess the impact of a building's orientation on overheating, Focal Engineering modelled a modular housing building in Burnaby, BC. The model assumed a 24% window-to-wall ratio (WWR) and operable windows for passive cooling. The project was targeting Step 3 of the BC Energy Step Code and so was required to meet a TEDI target of 30 kWh/m<sup>2</sup>/year. It also could not exceed 200 overheating hours per year.

The case study focused on a corner suite located on the top floor and explored the impact of two orientations on overheating.

- **Run 1:** West-facing suite
- **Run 2:** South-facing suite

The results of the exercise showed that the west-facing suite (Run 1) experienced excessive overheating and a total of **247 overheating hours**. In this scenario, additional cooling or design modifications would be required to achieve the project's targets.

In contrast, the south-facing suite (Run 2) achieved a lower overall risk of overheating at **156 overheating hours**.

Overall, the study demonstrates the importance of evaluating all of BC Energy Step Code targets early on in the design process when decisions such as orientation can still be impacted, to ensure both occupant comfort and code compliance.

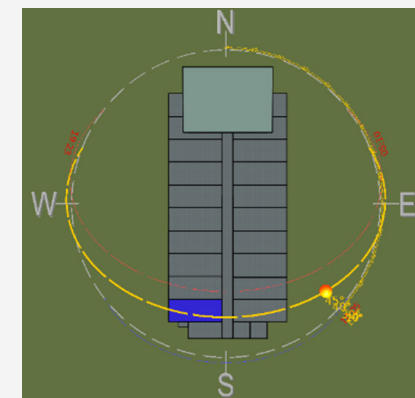
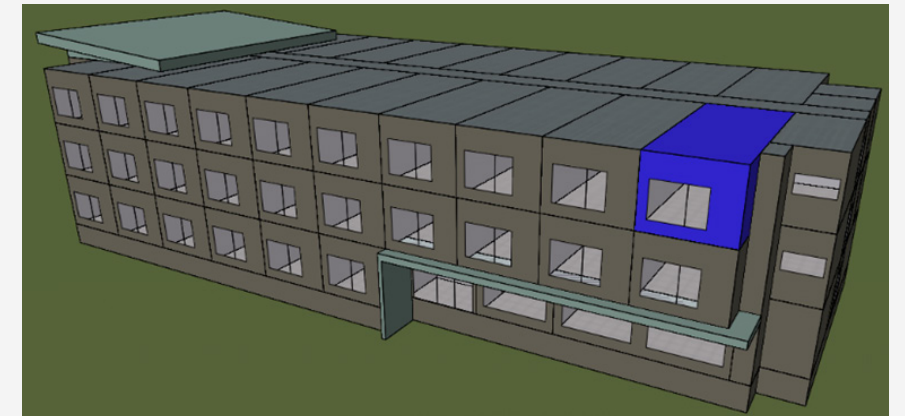

Run 1: West-facing suite

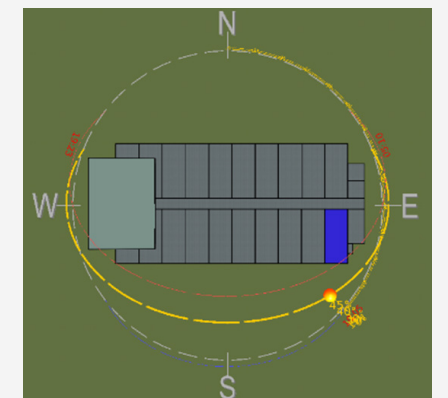

Run 2: South-facing suite

### ADDITIONAL RESOURCES

**Building Shape & Massing, Building Orientation, Thermal Mass & Window Design:** Vancouver Passive Design Toolkit, July 2009

**Building Massing, Windows Design:** BC Energy Step Code Design Guide

**Cool Roofs:** Mitigating New York City's Heat Island with Urban Forestry, Living Roofs and Light Surfaces, October 2006

## 04.2 Use Shading to Block Solar Heat Gains

Incoming solar radiation, or solar gains, are a major contributor to overheating. Designs have to manage solar gains carefully to make sure that unwanted solar gains are minimized while ensuring that the building can still harness useful solar gains in the winter for passive heating. A key way to achieve this balance is to use different shading strategies for each façade and for different spaces within the building.

### Exterior Window Shades

Exterior shades are the most effective at passive cooling, as they prevent solar gains from entering the space entirely. Designers can consider multiple types of exterior window shading.

**FIXED SHADES** can block direct radiation from the sun in the summer while allowing passive heating in the winter.

**OPERABLE SHADING** can be adjusted as needed, either manually or automatically.

- **Manually-operated shades** give occupants more control, but rely on occupants to be present in order to be effective.
- **Automatically-controlled shades** are more reliable in preventing unwanted solar gains, but reduce occupants' control over their space and are more expensive to install and maintain.

While interior window shades are often used, they are less effective as they allow solar gains to enter into the space, causing the shades themselves to absorb heat.

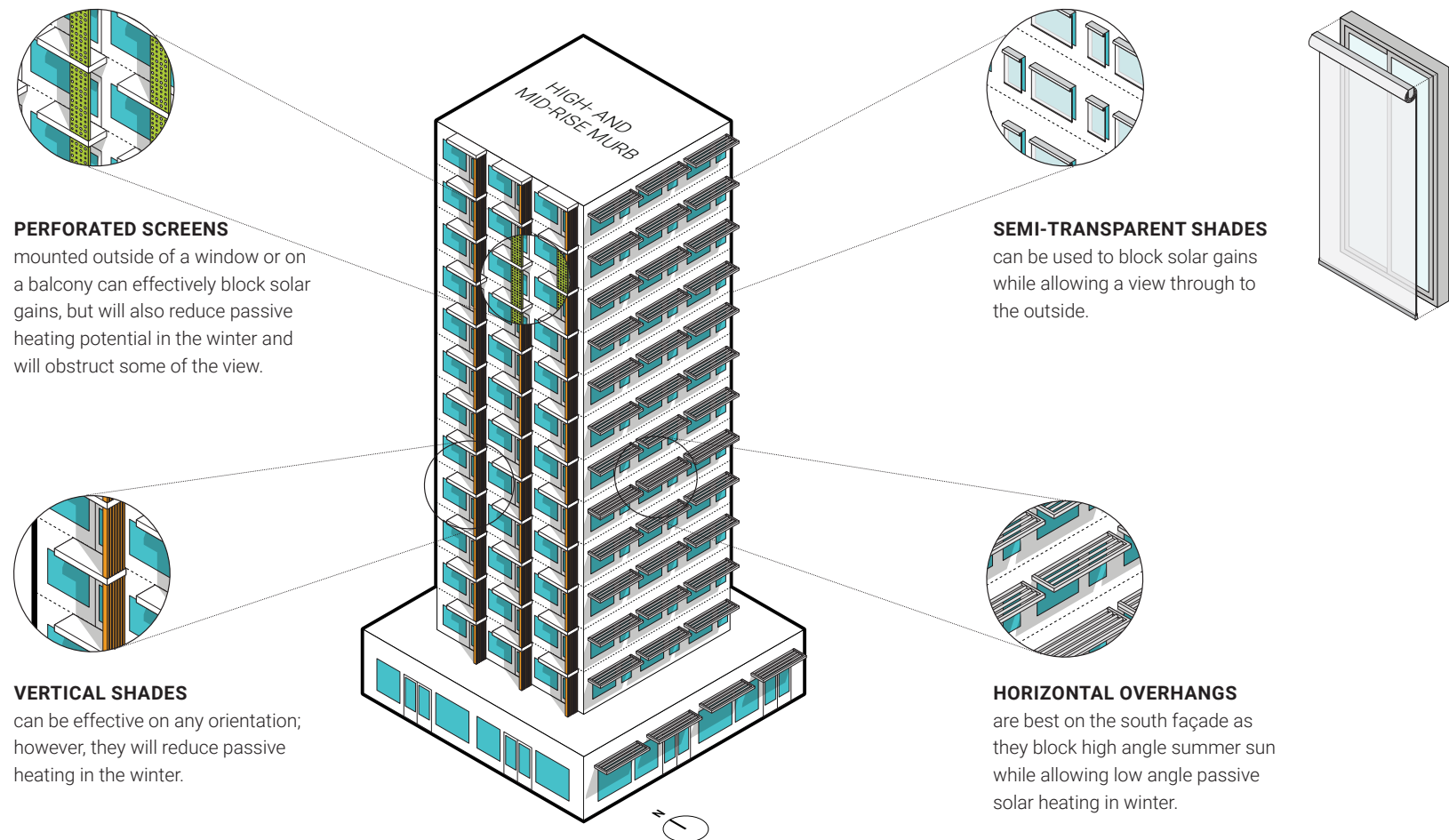

#### PERFORATED SCREENS

mounted outside of a window or on a balcony can effectively block solar gains, but will also reduce passive heating potential in the winter and will obstruct some of the view.

#### SEMI-TRANSPARENT SHADES

can be used to block solar gains while allowing a view through to the outside.

#### VERTICAL SHADES

can be effective on any orientation; however, they will reduce passive heating in the winter.

#### HORIZONTAL OVERHANGS

are best on the south façade as they block high angle summer sun while allowing low angle passive solar heating in winter.

### Vegetation

Exterior shading can be achieved by strategically selected and designed vegetation. In the summer, deciduous trees and other foliage can provide shade to windows while allowing solar gains to enter in the winter. Designers should consider the height of the vegetation (both current and future) and its distance from the building.

While vegetation can effectively shade all building orientations, it will require maintenance and will increase the building's water usage, which will have more of an environmental impact as the climate warms and more locations experience droughts. It is recommended that drought-resistant, indigenous species be considered wherever possible, with the possible addition of grey and/or rainwater capture.

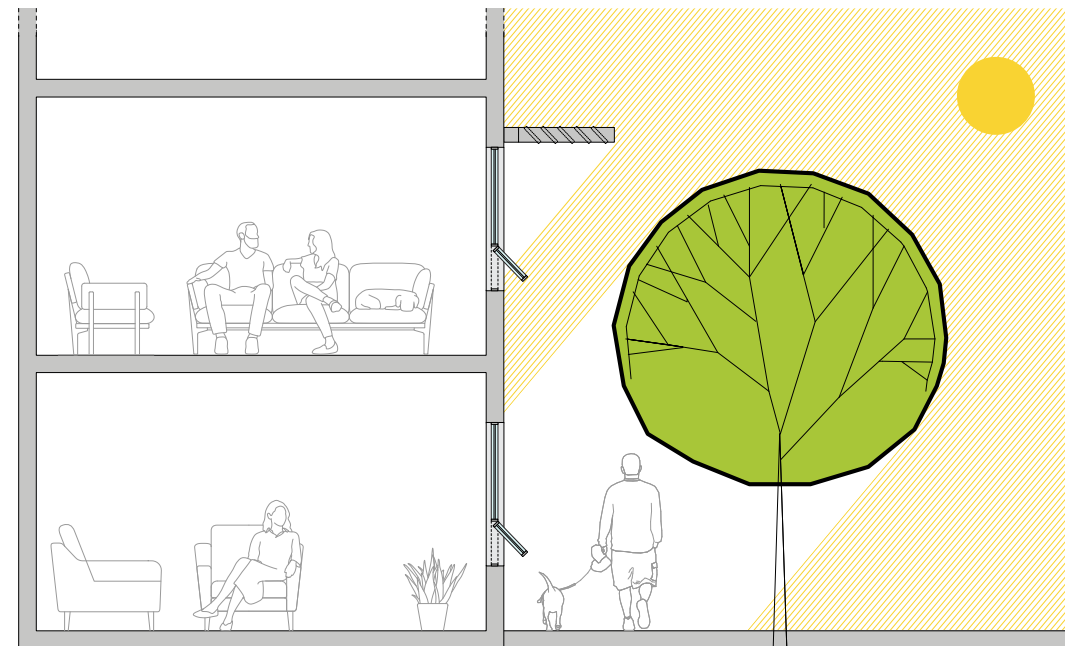

SUMMER SOUTH/WEST FACING FACADE

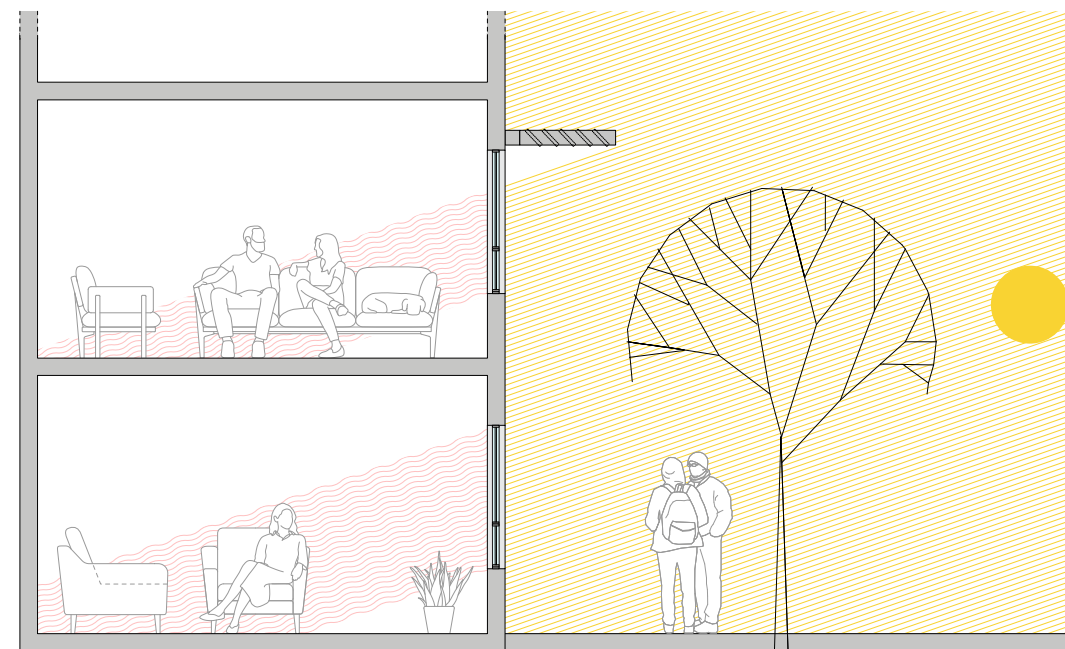

WINTER SOUTH/WEST FACING FACADE

### Solar Heat Gain Coefficient

Solar Heat Gain Coefficient (SHGC) is an important element in glazing selection and can be optimized for each façade of a building. Selecting glazing with an appropriate SHGC means finding the right balance between preventing overheating and reducing a building's thermal energy demand.

A SHGC of 0.4 means that 40% of the solar heat gains that land on the outside window surface enter into the space. A low SHGC reduces the risk of overheating. However, a SHGC lower than 0.28 starts to impact Visible Light Transmittance (VLT), which can make spaces darker and require additional lighting energy – adding more internal gains (heat) to the space. Conversely, a high SHGC allows more solar radiation to pass through the glazing, which reduces the building's need for heating energy but can increase the risk of overheating.

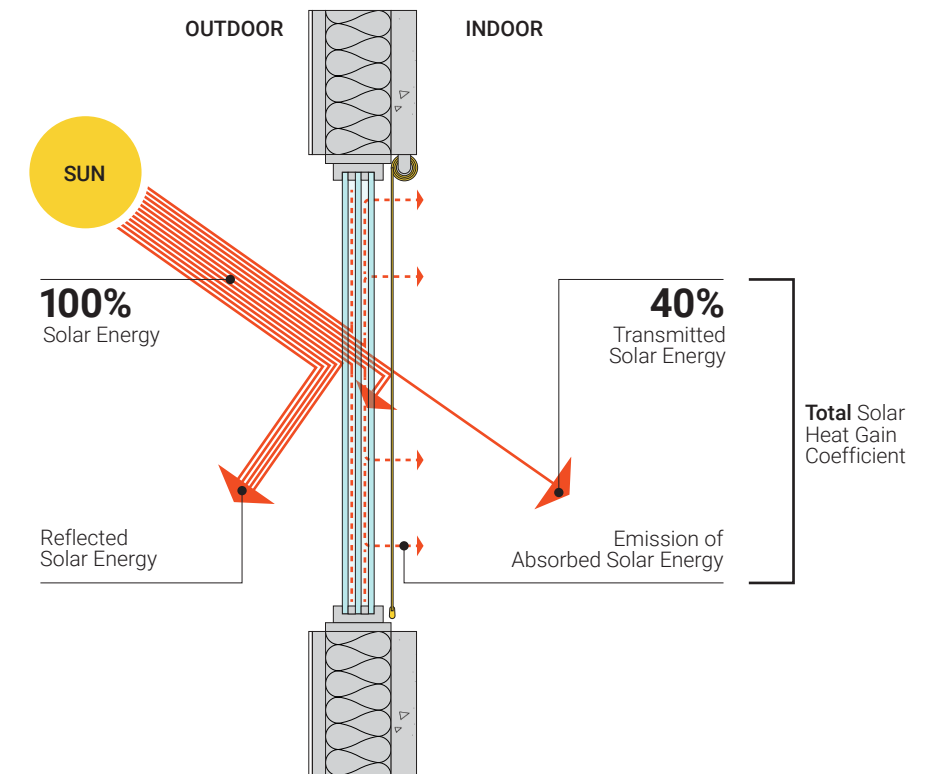

### Window Coatings

Window coatings, such as low-emissivity coatings, reduce the amount of radiation transferred through windows while allowing light to pass through.

### Electrochromic Glazing

Electrochromic glazing technology allows for automatic or manual control of a glazing tint and solar heat gain properties. These products have a similar effect to exterior automatically controlled operable shades.

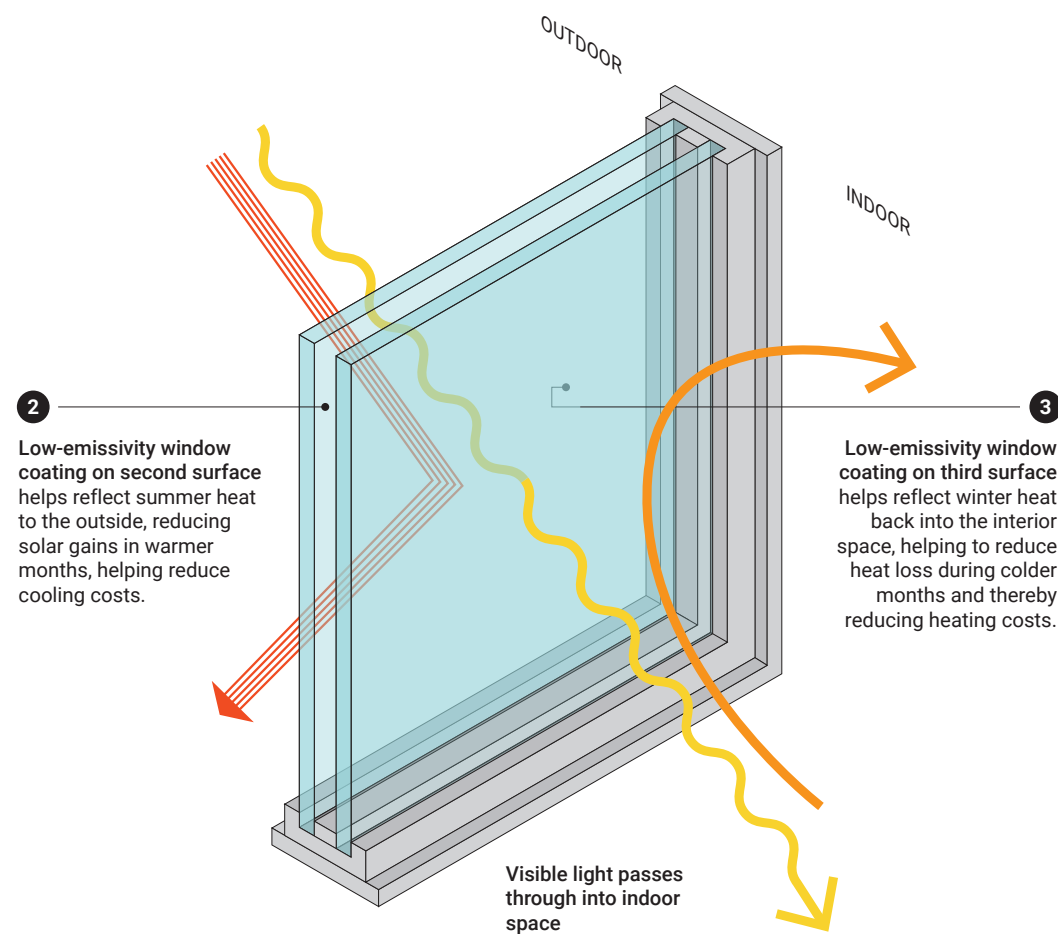

### Shading Strategies Comparison

	Fixed External Shades	Manual Shades	Automatic Shades	Vegetation	SHGC Selection	Window Coatings
Livability	👍👍	👍		👍👍		
Aesthetic	👍👍			👍👍		
No additional maintenance required					👍👍	👍👍
Controllability		👍👍	👍			
No increase in need for indoor lighting					👍*	
Glare control	👍			👍	👍*	👍

LEGEND 👍 Good 👍👍 Better \* Some SHGC reductions may impact visible light transmittance

#### KEY TAKEAWAY

- Install a reflective, cool roof to reflect heat away from the building
- Maximize glazing on the south façade and shade it appropriately to harness solar gains when they're wanted, while keeping east and west glazing low
- Select glazing with a low U-value and a SHGC that balances the need to prevent overheating (i.e. a low SHGC) with the need for free heating (i.e. a higher SHGC)

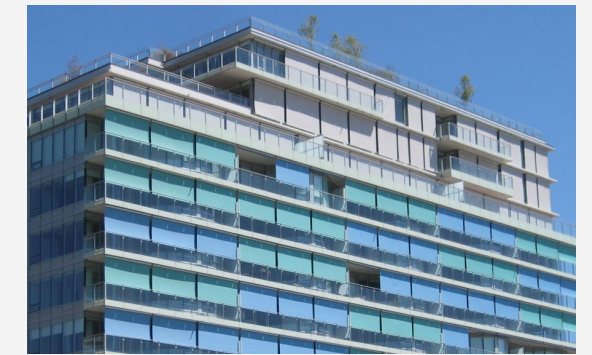

#### CASE STUDIES

#### Shading in Vancouver's Olympic Village

Several of the Olympic Village's buildings feature diverse shading strategies. Of note are the automatically controlled shades that are mechanically raised and lowered in response to measured incoming solar gains. This strategy helps to block solar heat gains when they are greatest, and avoids relying on occupants to remember to lower them. Shades are also semi-transparent so occupants can still enjoy an unobstructed view to False Creek and downtown.

**Top** *The Brook at False Creek, Vancouver, BC*  
**Bottom** *Semi-transparent shades from inside suite*



## 04.3 Cooling via Natural Ventilation

Once other passive design strategies have been explored, the risk of overheating can be reduced even further by removing heat gains from inside a building using methods of natural ventilation.

Natural ventilation is the process of increasing the flow of outdoor air into a space through openings in the building envelope, such as windows. Using natural ventilation help reduce a building's reliance on mechanical systems to provide cooling and help occupants achieve thermal comfort for most of the year. Many occupants also like being able to open a window to adjust their indoor environment.

The most effective way to achieve natural ventilation is through the use of operable windows or vents in the building envelope. There are several aspects that need to be considered to ensure that they are as effective as possible.

### CONTROL

Automatic controls can be programmed in common areas to open windows and/or vents based on a schedule or sensed input. Manual window controls should come with instructions for occupants on when to open or close windows to maximize the potential of natural ventilation and cooling.

### OUTSIDE CONDITIONS

Occupants will be less likely to open windows if exterior conditions are unfavourable, such as noise, poor air quality (e.g. noise, smoke, dust or smells) or uncomfortable conditions (high temperatures or humidity).

### OPERATION AT NIGHT

Nighttime ventilation allows buildings to be passively pre-cooled in preparation for the next day. Openings and vents should be designed to restrict access by people or animals where necessary, and located away from sources of allergens and pollutants.

### EFFICIENCY

Operable windows often have a higher (worse) U-value than fixed windows and can decrease building airtightness. Designers should look for windows with lower overall U-values, consider the effectiveness of the window seal, and look for a multi-point locking mechanism to ensure airtightness.

### LOCATION

The location of the residential unit, elevation and height, will impact the size of opening required, especially if only single-sided ventilation. Wind pressure will have a greater impact as height increases and external gains can vary across a single elevation due to shading from neighbouring buildings.

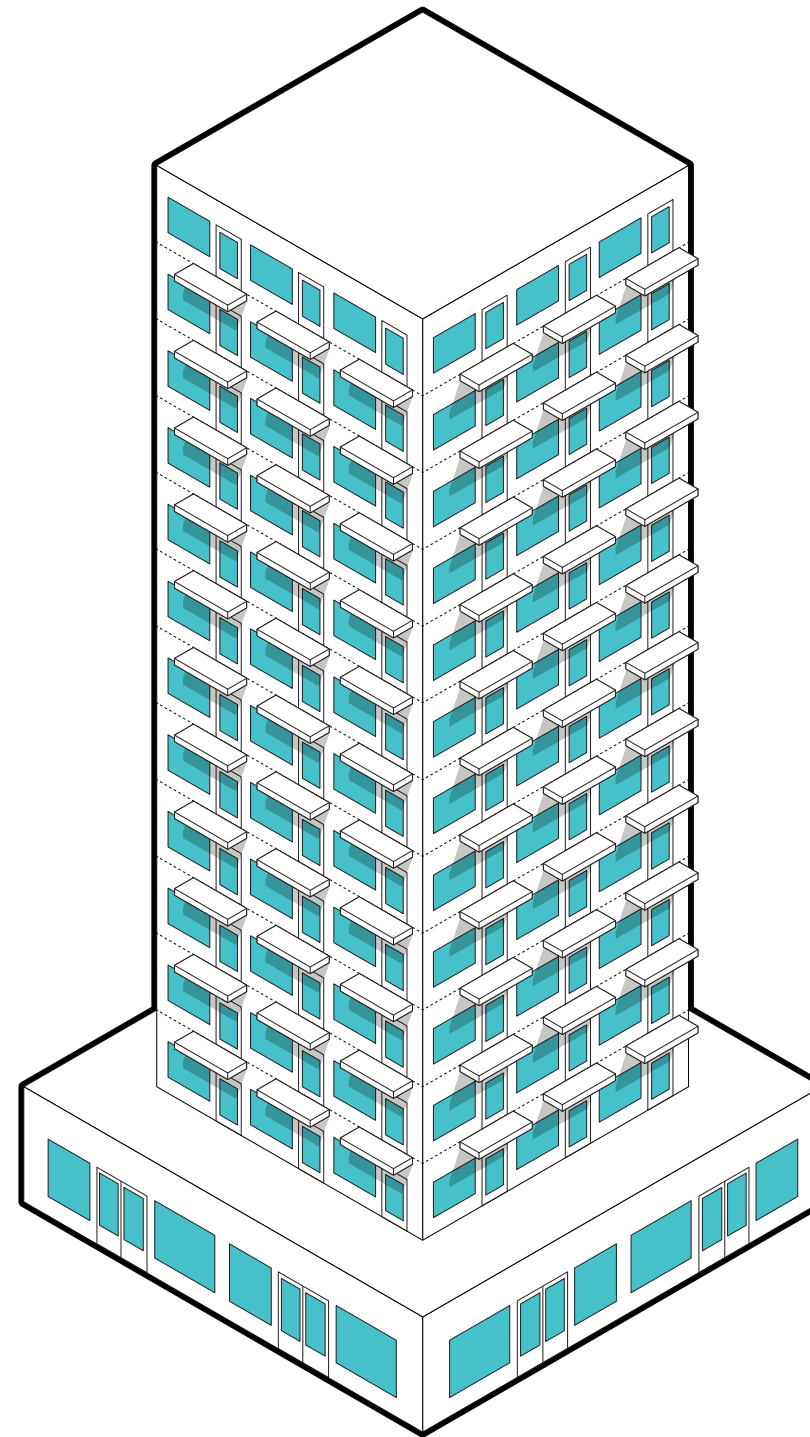

### POSITION

The vertical position of openable windows and vents should be considered to mitigate the risk of unintended access on the lower floors or fall hazards on the upper floors.

### SIZE

The size a window, the depth of its opening, and any restrictions on how far they can open should all take Code requirements and safety concerns considerations into account. Small operable windows or vents that are restricted may be ineffective in providing natural ventilation and cooling.

### Key issues to keep in mind when designing for operable windows:

- Indoor and outdoor air temperatures will be similar when windows are open, which can cause thermal comfort issues at higher temperatures, particularly as the climate warms.
- Air quality can become a concern when using operable windows for cooling, since the air isn't filtered before entering the room.
- Building occupants may be less likely to open their windows if they are located in a noisy area, reducing the effectiveness of the strategy.

## CASE STUDIES

### The Impact of Operable Windows

BC Housing and Nanaimo Affordable Housing Society

A concrete and wood frame affordable senior housing facility was modelled to explore the impact of operable windows on the building's potential for overheating. As its original design resulted in **2,788 overheating hours** (far above the 200-hour target), two passive cooling strategies were modelled to see if they made a difference.

First, horizontal and vertical shades were added to several southeast and southwest facing windows. This resulted in a noticeable reduction in thermal discomfort, down to **1,864 overheating hours**. To further reduce overheating, operable windows were then included. Windows were assumed to be open between 6am-10pm (when occupants are awake to open them), when room temperatures exceeded 23°C, and when the outside air temperature was lower than indoor air temperatures. This resulted in a significant reduction in overheating, down to only **162 overheating hours**.



Above Low Hammond Rowe Architects (LHRA)

### Single Sided Ventilation

Spaces can be naturally ventilated where openings are placed on one side of the space. However, this approach tends to be less effective, in that a single opening is limited in terms of how much of the space can be sufficiently ventilated. When using single-sided ventilation strategies, opening areas should be as large as possible.

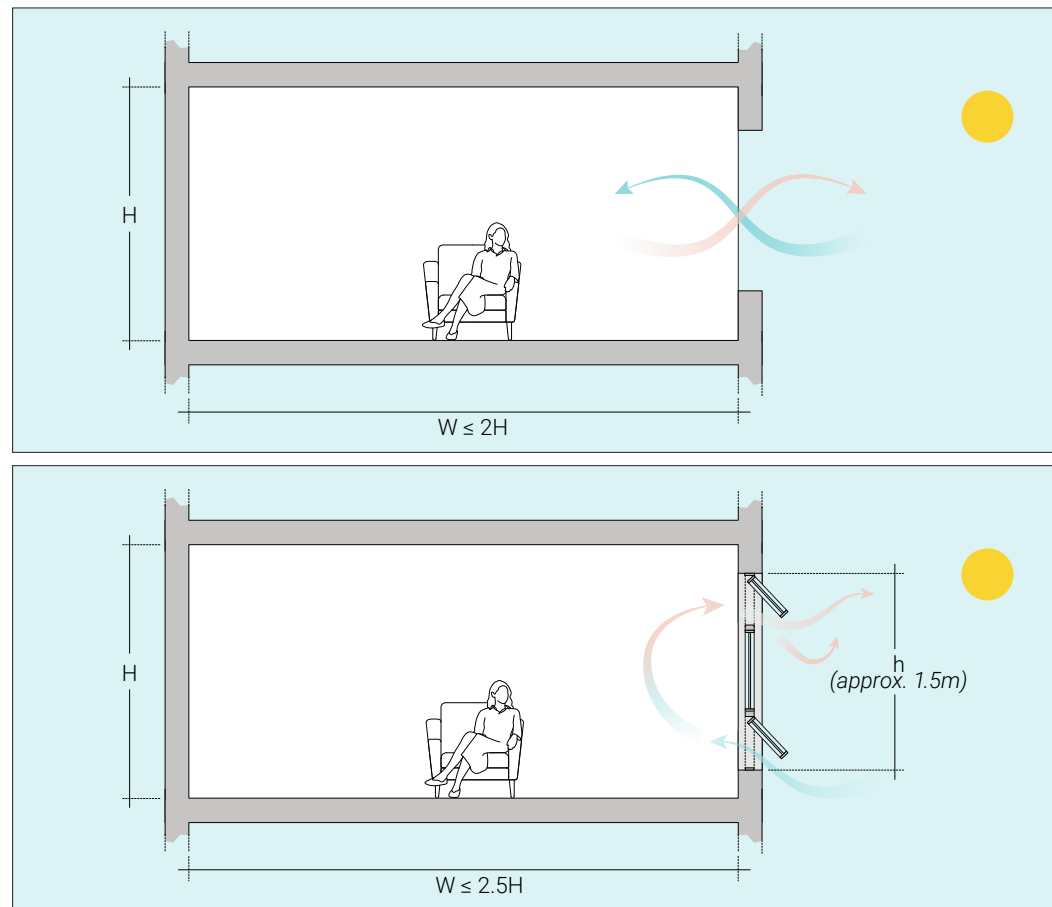

### Cross Flow Ventilation

Placing windows on different facades generates greater air flow, due to the difference in pressure between different facades. As cross-ventilation is twice as effective as single-sided ventilation, openings can be smaller than those used in single-sided ventilation.

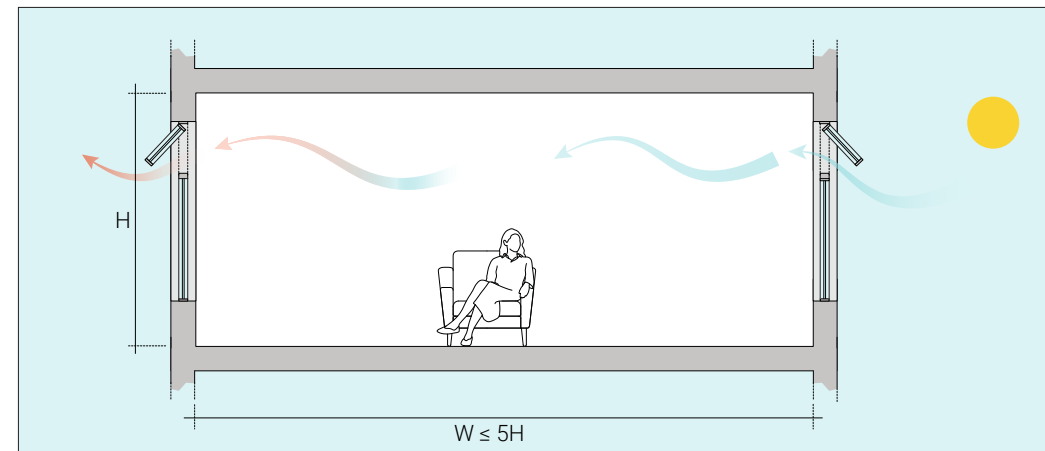

### Designing Right

To successfully implement passive ventilation cooling strategies, each space of a building must be designed to allow a sufficient volume of airflow to counteract any heat gains. Designers should design the façade to ensure solar gains are minimized, and model interior spaces using dynamic simulation tools. Modelling to higher standards, such as ASHRAE 55.1 or the CIBSE Technical Memoranda, will help identify the potential risk of overheating and allow an exploration of the impact of various passive and active approaches. Using future climate files (e.g. RCP 8.5 for 2050) in modelling will ensure the building's resilience in the coming decades.

#### KEY TAKEAWAYS

- Include operable windows and vents into building design to reduce the need for active cooling.
- Consider window/vent size and placement for optimal airflow.

## 04.4 Couple Passive Cooling with Active Approaches

Passive cooling strategies have several benefits, from lower energy use to increased occupant comfort. However, they are increasingly insufficient in providing thermal comfort during the warmer months of the year.

Passive systems can be enhanced by incorporating fan assistance to help increase overall airflow. This is a cost-effective solution to improve thermal comfort in the shorter term, and reduces the need to add a source of mechanical cooling during warm periods that would add to the building's overall energy demand.

### Use a Bypass in Heat Recovery Ventilation

Many high-performance buildings use heat or energy recovery ventilation (H/ERV) strategies to reduce winter heating loads. Where these systems are used, they can be designed to include a bypass for summer, which allows cooler outside air to avoid absorbing any heat from the warm air being exhausted. This approach can be used when indoor building temperatures are higher than outdoor summer temperatures, and can be used in parallel with operable windows and vents to enhance the passive ventilation.

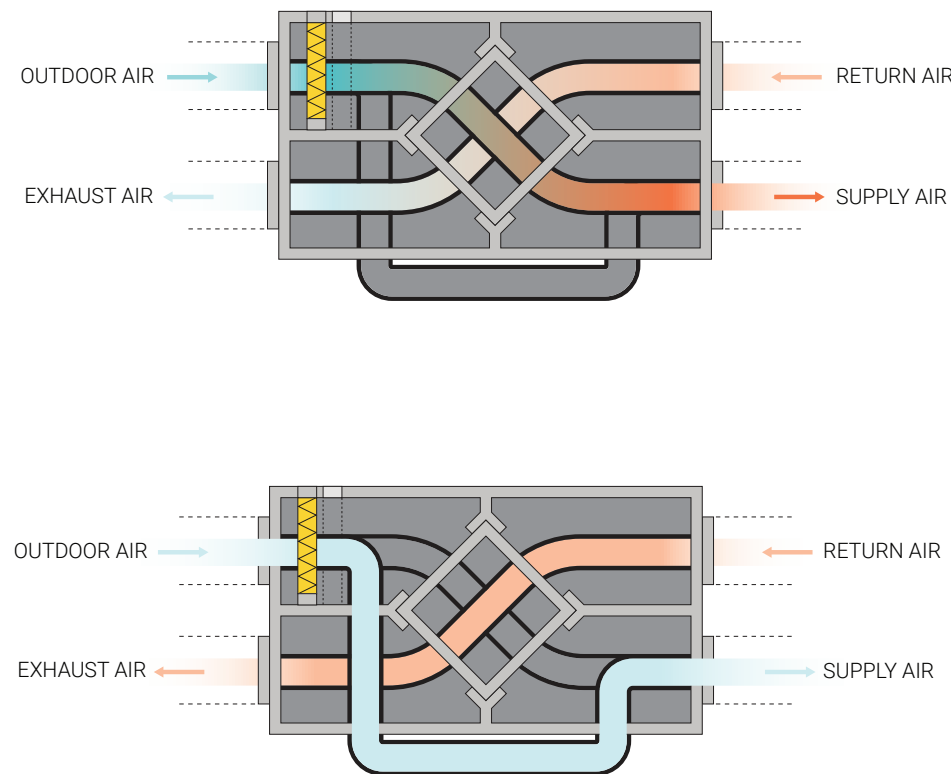

### Drive Air Movement with Exhaust Fans

Air movement can also be increased using supply or exhaust fans. This strategy is particularly effective in rooms or suites with a single orientation – in other words, where natural cross-flow ventilation is impossible. When outdoor temperatures are cooler than inside temperatures, an open window at one end of a space and an active exhaust fan at the other will drive air movement.

Ceiling fans can be effectively used to increase air movement within a space, improving the thermal comfort for occupants.

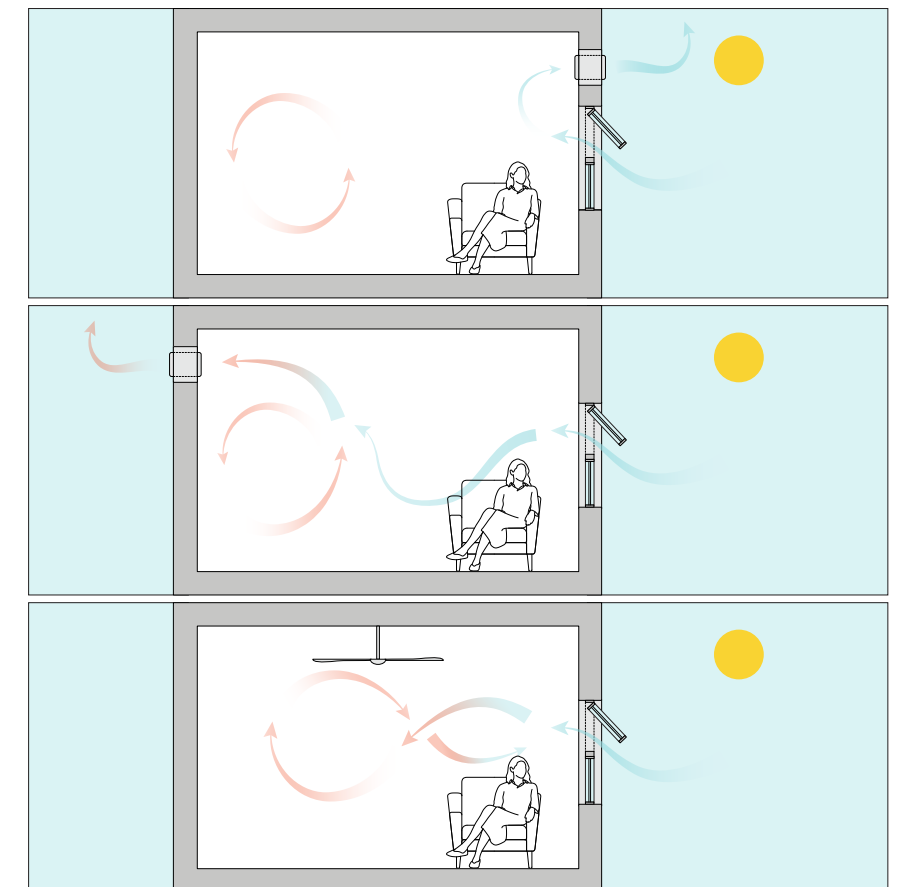

### Temper Supply Air

Central ventilation units are commonly used in rental buildings and buildings in higher climate zones in BC, and can be adapted to provide a degree of cooling to each suite at minimal capital cost. For example, a central HRV used to supply and exhaust air to and from each suite can be outfitted with a cooling coil to temper the supply air. During the summer months, this approach can deliver a significant portion of the required cooling.

When tempering the supply air, increasing the supply air ventilation rate above the ASHRAE minimum flow rates will increase the cooling capacity and provide longer-term resilience for the building. The impact of the additional fan energy on the TEUI should be assessed and considered during the design process.

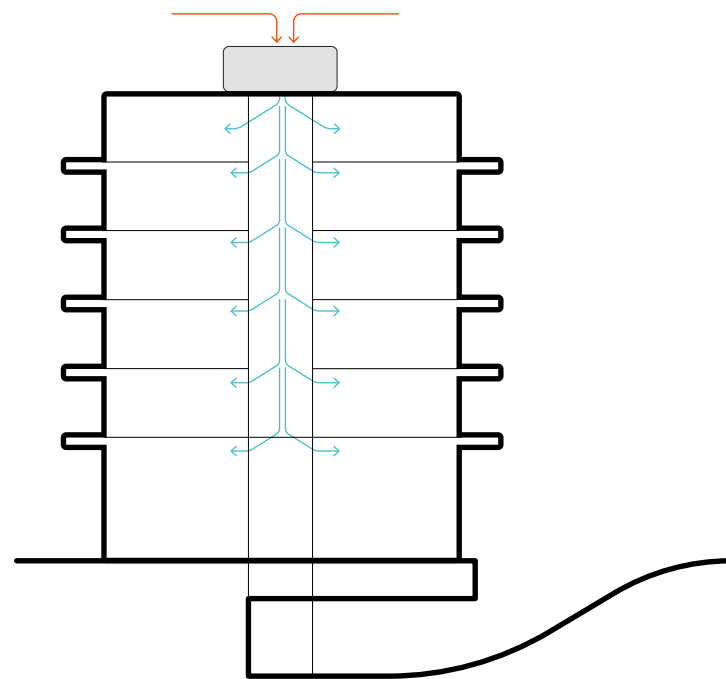

### CASE STUDIES

#### Vidorra Developments

Vidorra Developments' Orion project in Pemberton, BC is an example of hybrid cooling applied in the local context. This three-storey residential building has 45 condominium units, and focuses on both a high-performance envelope and reduced loads. The envelope features triple-pane windows built with solar control glass that are set in the middle of the wall to limit thermal bridging, coupled with double walls insulated for a combined performance of R42. The roof is insulated to R70, and is equipped with solar panels that generate most of the building's needed energy. This envelope-first approach minimizes the need for more complex HVAC systems.

Passive cooling at Orion relies primarily on the low heat loss/gain envelope and solar control glass, but also employs night flushing by running the energy recovery ventilator (ERV) at double the ventilation rate to reset the building's thermal mass for the next day. Higher energy use from increasing the airflow is offset by using a high-performance ERV. When necessary, the project can also provide mechanical cooling using air-sourced heat pumps. This approach minimizes envelope penetrations and is extremely cost effective compared to conventional construction due to its simplicity.



**Top** Orion, Vidorra Developments

**Bottom Left** Soffit insulation with simple ventilation ductwork

**Bottom Right** Wood frame structure with triple-pane windows set in the middle of walls

## 04.5 Add a Source of Cooling

While designers should always make use of passive cooling solutions first, peak summer conditions today are already starting to make these strategies insufficient in providing occupants with thermal comfort year-round. When passive strategies are no longer viable on their own, mechanical cooling is required.

High-performance, energy efficient, active technologies such as heat pumps are frequently used as a means of cooling in high-performance buildings, as they can provide both heating and cooling using BC's low-carbon electricity. Heating and cooling can be distributed around a building using one of three mediums: air, water or refrigerant.

### AIR

Using the ventilation system in a suite or building to deliver cooling via a cooling coil can be a cost-effective solution. However, their use can increase a building's overall energy use, which will negatively impact the TEUI of a high-performance building. Designers can consider zoning the ventilation system where there are significant variations in the need for cooling (e.g. because of different solar gains) in different parts of the building to reduce energy demand.

### WATER

Using water in place of air is a more energy efficient way to remove heat from a space. Where a building uses simultaneous heating and cooling, rejected or "waste" heat can also be easily distributed to areas of the building that need it, which improves the energy efficiency of the system even further. However, this requires designers to include a hydronic distribution system in addition to the building's ventilation distribution system, which can increase overall capital costs.

### REFRIGERANT

Refrigerant is a fluid used in heat pumps that changes its state from a liquid to a gas and back again, and is very efficient at moving energy around a building. Refrigerants also make use of smaller pipe sizes than those required for chilled water or for ducts, which can help in building design. However, designers must carefully consider the type of refrigerant they specify to avoid those with significant Global Warming Potential, or GWP.

### Heat Pumps

Heat pump technologies are designed to different levels of efficiency. Heat pump efficiency is generally measured in terms of its coefficient of performance (COP), which is a measure of how efficiently the pump converts electricity into usable thermal energy. Selecting a high-efficiency heat pump can limit the impact of active cooling systems on a building's Total Energy Use Intensity (TEUI).

**Air Source Heat Pumps (ASHP)** use air as a heat sink. The efficiency of air source heat pumps varies as the outdoor air temperature changes from season to season. Since peak winter and summer air temperatures can decrease the COP of an air source heat pump, they are less ideal for use in climate zones with temperatures that vary significantly.

**Ground Source Heat Pumps (GSHP)** use the ground as a heat sink, and a fluid to move thermal energy between the ground and the building. As ground temperatures remain relatively constant throughout the seasons, variations in their efficiency are minimal. However, additional infrastructure is required to access the sink, and so they can be more expensive to install.

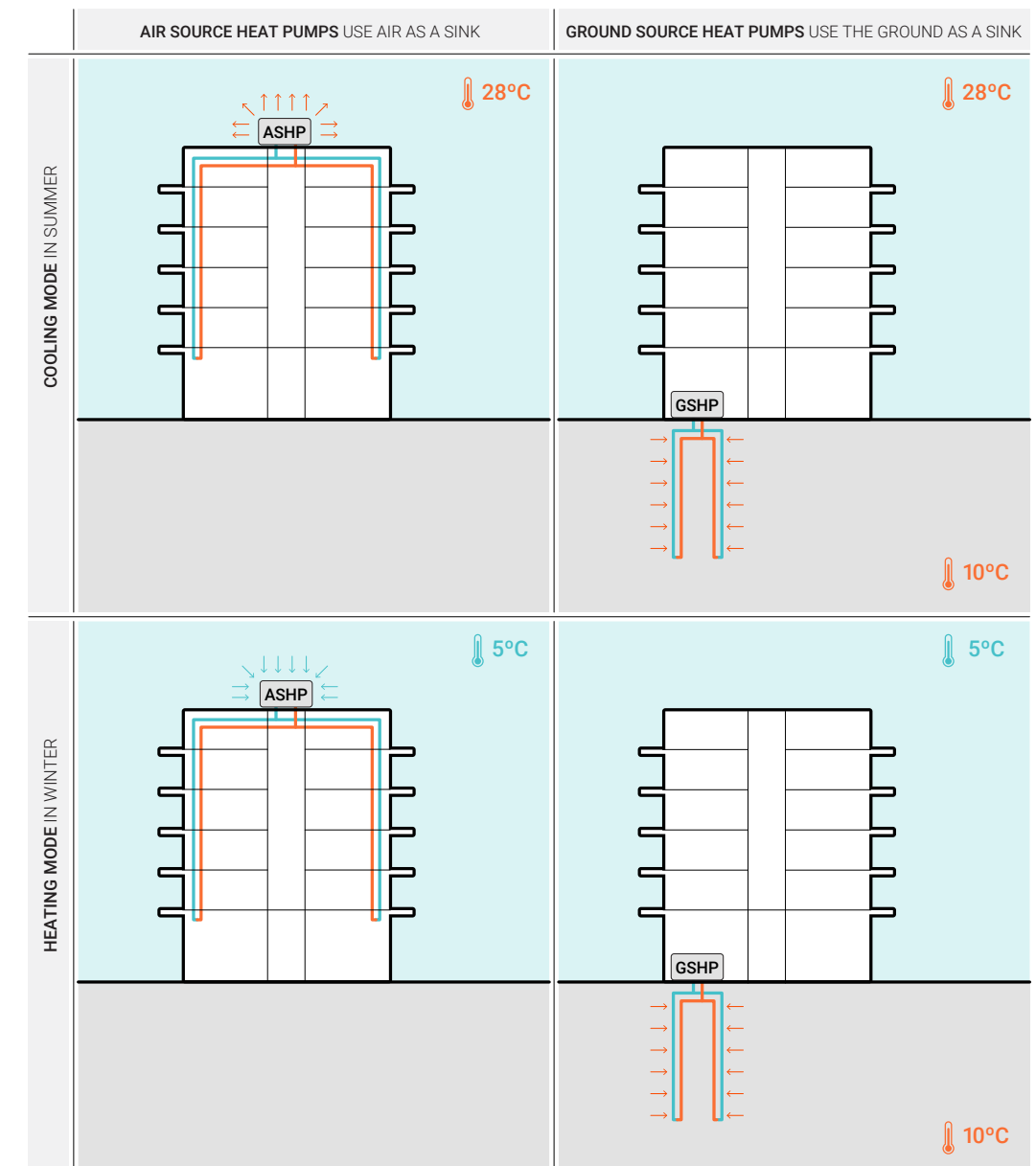

### Central or Distributed Cooling

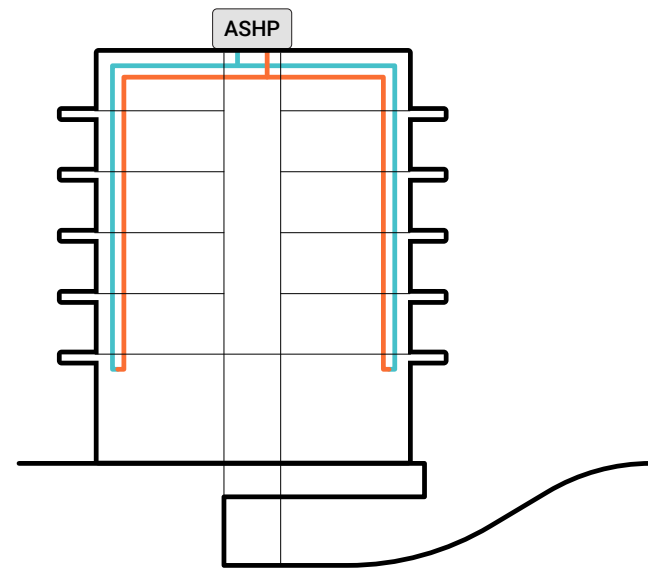

Cooling provided by heat pumps can be distributed by either a centralized or decentralized system.

**Centralized systems** often make use of a central cooling unit (such as a rooftop ASHP) that generates the cold air, water or refrigerant that is in turn supplied to each zone in the building. Central systems typically incur lower costs to design, install, and maintain, but are less useful where cooling is required in only a few spaces of a building.

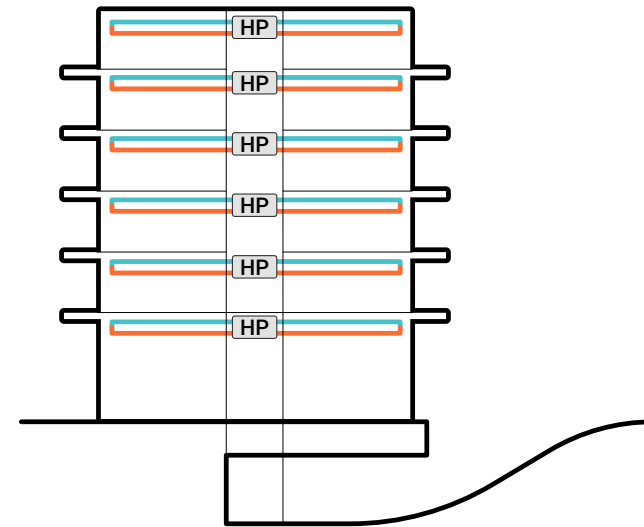

**Distributed systems** have multiple heat pumps located throughout the building that supply each zone or a group of zones. This approach offers greater flexibility in building design, but typically makes for higher capital costs.

### VRF Systems

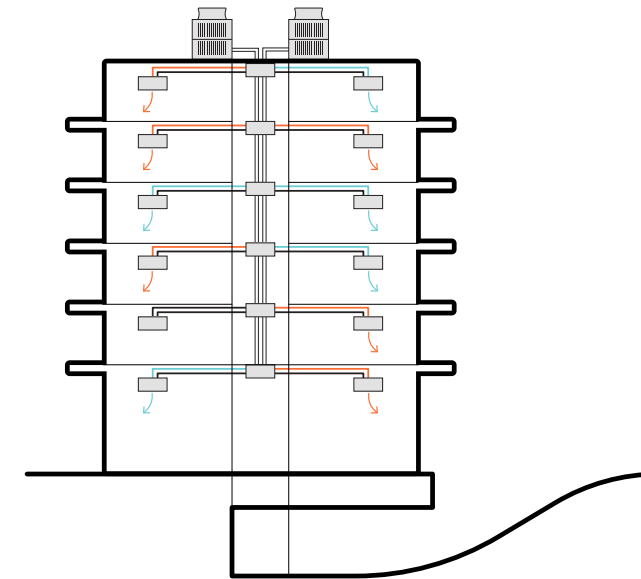

**Variable refrigerant flow (VRF)** or Variable Refrigerant Volume (VRV) systems are gaining traction in North America because of their ability to provide heating and cooling simultaneously. Some systems can also move heat from areas that are too hot to areas where heat is required, increasing the system's overall efficiency. VRF/VRV systems allow thermal comfort to be maintained across multiple suites of a building that have varying heating and cooling loads without the need to add a secondary system. Like heat pumps, both water and air-cooled VRF/VRV systems are available on the market.

### Issues to keep in mind when selecting a mechanical cooling option:

- Select systems that make use of low-carbon energy to reduce a building's GHGI
- Select a cooling system with a higher coefficient of performance (COP) to minimize the impact on the building's TEUI
- Carefully consider how to size, operate and zone a mechanical cooling system to optimize performance, especially if different spaces experience different peak temperatures at different times of the day
- Where possible, connect residential suites to commercial retail units via a common cooling system to allow waste heat to be transferred between different space uses, improving overall efficiency
- Locate external equipment in such a way that building occupants and neighbouring buildings won't be affected by noise

### ROUGH-IN FOR FUTURE COOLING

Where a project either does not require mechanical cooling today or lacks the funding to provide it, design teams can consider "rough-ins" to allow mechanical cooling to be installed later. For example, designers can plan future routes for running future refrigeration or chilled water lines, specify equipment with space to add a cooling coil, or size airflow rates to meet future cooling loads. The provision of future electrical capacity to accommodate future mechanical cooling, both building-wide and in specific spaces, should also be considered.

**Mixed Mode Systems**

Mixed mode systems offer the ability to cool mechanically-ventilated spaces via both natural ventilation and mechanical cooling. What option is used at any given time is often guided by external conditions.

Under current average summer temperatures, operable windows provide an adequate source of cooling. This strategy helps to reduce energy use, as mechanical cooling is not necessary.

When outdoor summer temperatures become too hot, or when outdoor air quality is poor, mechanical cooling can be used to maintain thermal comfort instead. This strategy helps to maintain indoor air quality as air is filtered through the mechanical system.

Mechanical cooling systems that allow for increased capacity in the future improve a building's resilience to increasing future temperatures. Separating mechanical cooling potential from ventilation air wherever possible helps to increase the overall efficiency and flexibility of the system.

**MECHANICAL HEATING DURING PEAK WINTER**

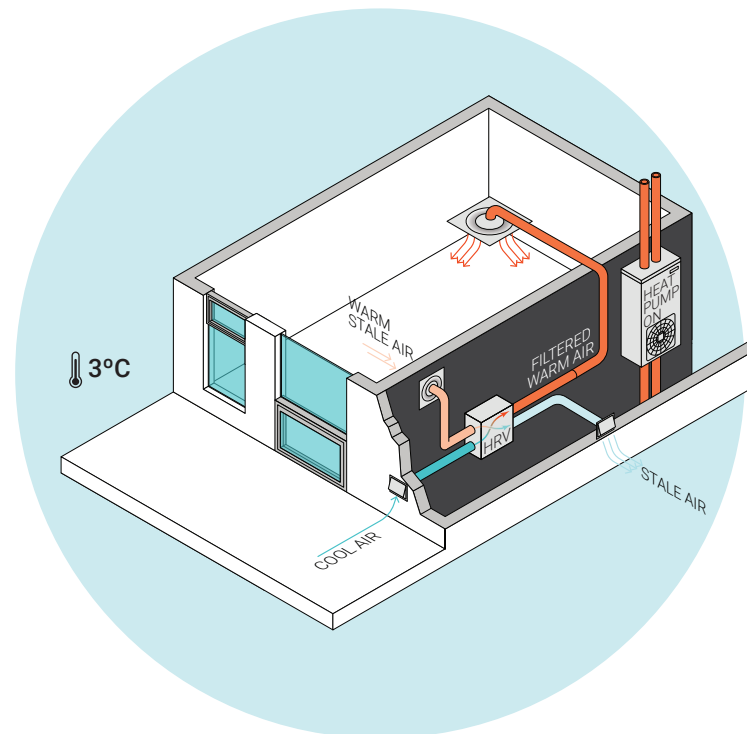

**PASSIVE AND MECHANICAL COOLING DURING SHOULDER SEASONS**

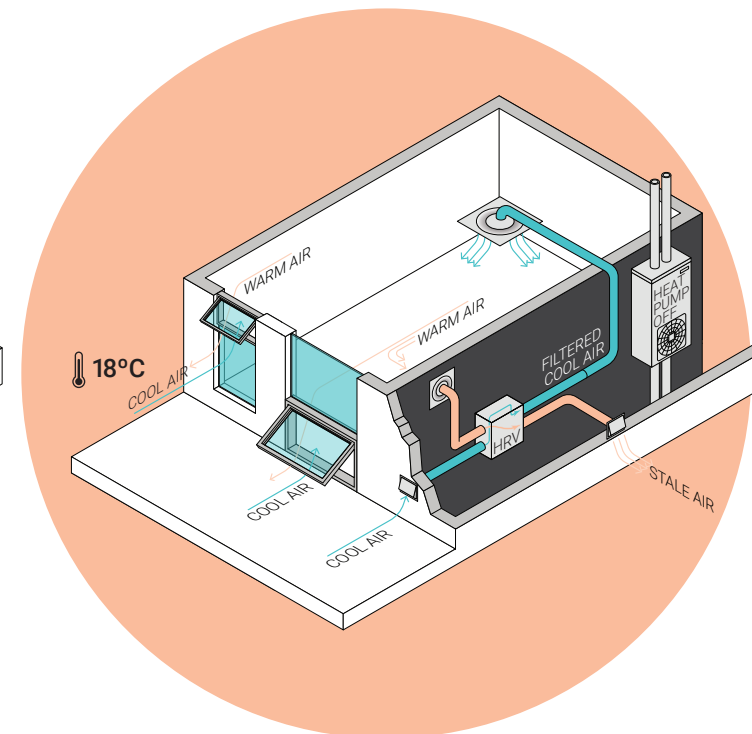

**MECHANICAL COOLING DURING PEAK SUMMER**

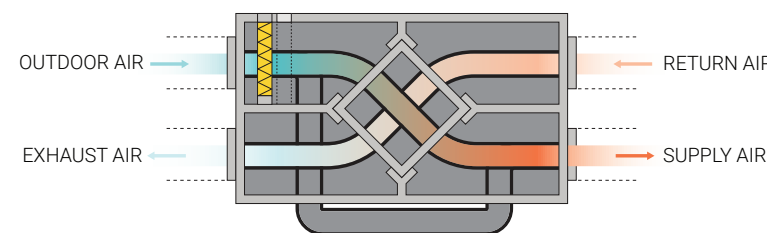
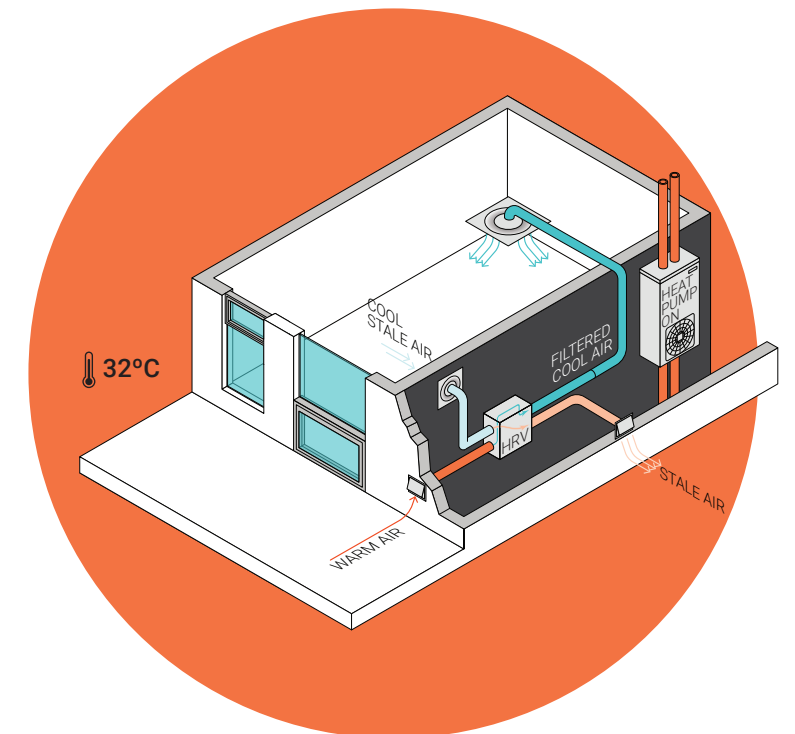

**FILTERED HRV IN FULL HEAT RECOVERY MODE**

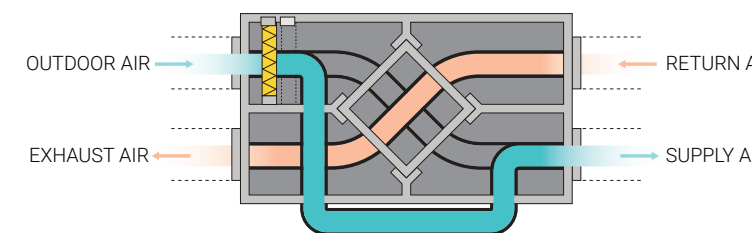

**FILTERED HRV IN FULL BYPASS MODE**

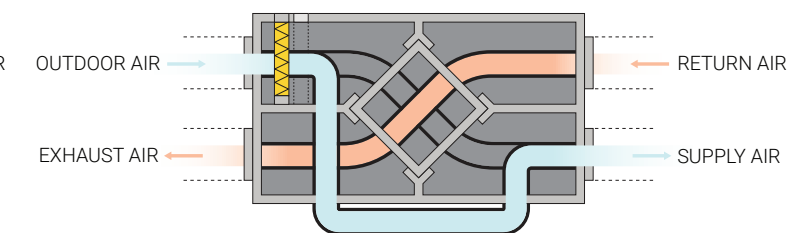

**FILTERED HRV IN FULL BYPASS MODE**

**KEY TAKEAWAYS**

Provide a source of mechanical cooling to complement passive cooling measures to ensure thermal comfort is achieved under current and anticipated peak conditions.

Separate ventilation and cooling systems to improve system flexibility and optimize energy efficiency.



CASE STUDIES

**Cambie Gardens**

Cambie Gardens is a master-planned community in Vancouver designed to provide community members with access to health and support services alongside independent living options. Each unit includes in-suite controlled forced-air cooling, heating, and ventilation, controlled by LCD smart thermostats that allow residents to control temperatures, even when away from home. The building uses air source heat pumps and boilers with fan cool units, as well as low-E windows to increase insulation and UV protection.



Above Cambie Gardens, IBI Group



Above Cambie Gardens, IBI Group

**Modello**

The Modello development in Burnaby combines variable refrigerant flow (VRF) zoning with a ground source heat pump system for heating and cooling. This combination allows for precise temperature control over the many floors of the building, regardless of the time of day, season, or unit orientation. Each unit is also equipped with individual thermal metering, allowing occupants to control both their comfort and utility costs. Additional features include LED lighting connected to motion sensors, and roller shades for the floor to ceiling windows that can be motorized and integrated with smart home technology.



Above Modello, Chris Dikeakos Architects Inc.



Above Modello, Chris Dikeakos Architects Inc.

## 04.6 Filter the Air

As forest fires increase across British Columbia, the risk of air quality advisories also increases. This and other sources of poor air quality can be addressed in building design by making sure that mechanical ventilation systems that provide cooling are also designed for a higher level of filtration.

Designers should identify the number and intensity of local sources of air pollutants to determine the level of filtration that should be used. In general, designers should try to exceed industry standards of MERV 8 by using a minimum of MERV 13 filters in system design. However, higher performance filters often have higher maintenance costs, as they require replacement more often. Failure to replace filters according to their schedule will also result in lower performance. This is particularly a risk where filters are maintained by occupants themselves.

Where higher levels of filtration are inappropriate or unfeasible, systems can be designed to accommodate additional filtration media, or the use of higher performing filters during air quality advisories. Designers can incorporate higher performance filters into ventilation units with minimal upsizing of the fans where they are used for short durations (e.g. during air quality advisories). Activated carbon filters should be used in buildings located in areas with high concentrations of gaseous contaminants (e.g. VOCs).

Building operators must ensure all filters are replaced as required and that secondary filters are removed upon air quality advisory ending.

### Dedicated Outdoor Air Systems

Dedicated outdoor air systems (DOAS) are systems used to provide 100% of a space in a building with fresh outdoor air, flushing the building of contaminants and improving air quality. DOAS are most effective in improving air quality when compared with other ventilation systems, and should be designed to include heat recovery to improve energy efficiency.

### Issues to keep in mind when designing for indoor air quality:

- Ensure any air intakes to mechanical ventilation systems are located as far away from allergens and pollutants as possible, and on the shaded side of the building. Protect intakes from pests and animals.
- Use demand control ventilation to control pollutant concentrations in a space and reduce energy use by supplying only the amount of outdoor air that is required.
- Reduce the impact of higher performance filters on energy efficiency by selecting filters with a minimum depth of 100mm.

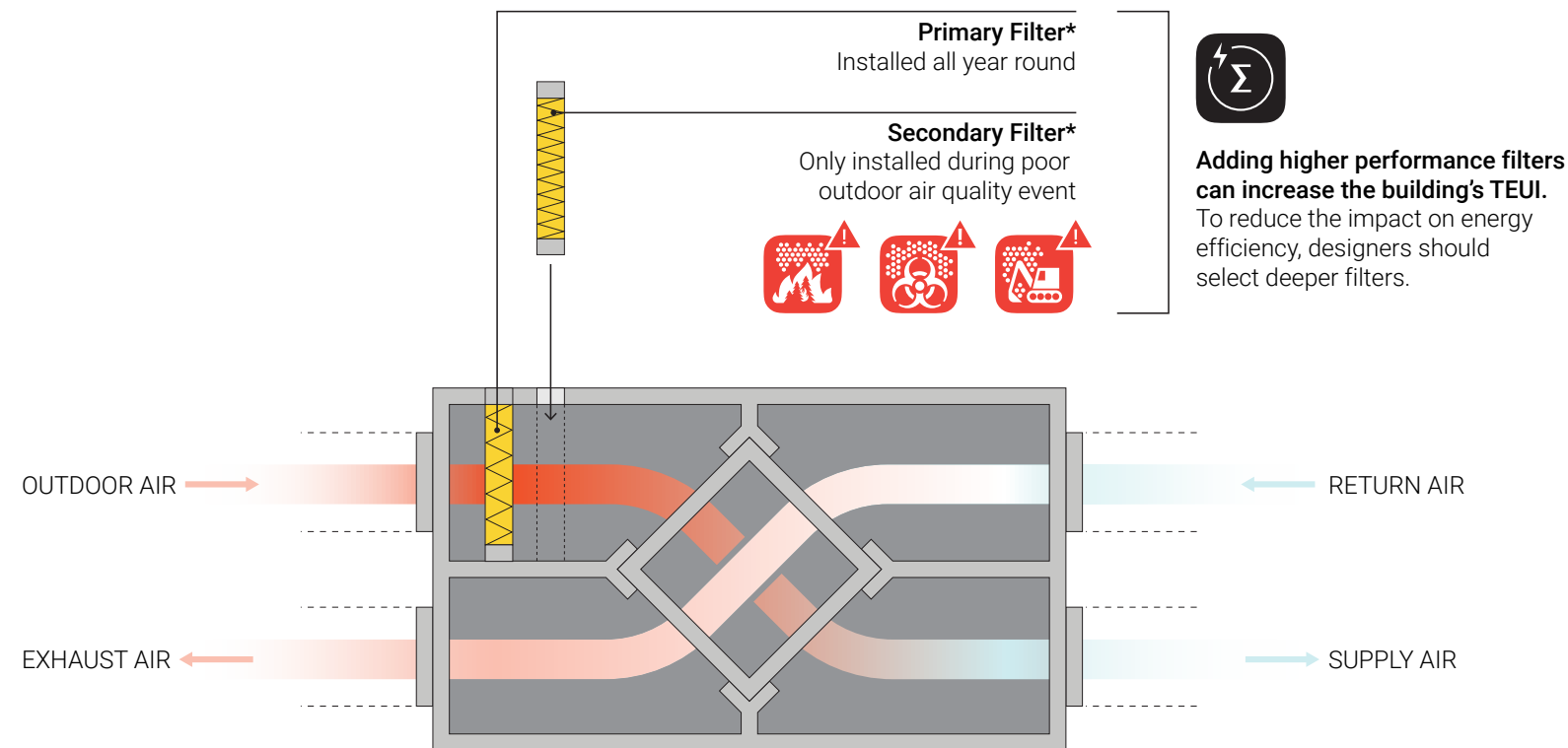

\*Note that filters can be either internal to the unit, or external downstream of the supply fan.

### Key Terms

**MERV** (or minimum-efficiency reporting value) is a measurement scale designed by the American Society of Heating, Refrigerating and Air-Conditioning Engineers) ASHRAE to rate the effectiveness of air filtration systems. The scale ranges from MERV 1 to MERV 16, depending on the minimum particle size that is filtered out of the air.

**HEPA** (or high-efficiency particulate air) is a type of air filter that works by forcing air through a fine mesh that traps harmful particles such as pollen, pet dander, dust mites, and smoke. To meet the HEPA standard, air filters must remove 99.97% of particulates greater than or equal to 0.3  $\mu\text{m}$  from the air that passes through them.

**ACTIVATED CARBON** is a method of filtering that uses chemical absorption to remove contaminants and impurities. Activated carbon has properties that allow it to remove volatile organic compounds (VOCs), odours, and other pollutants, but do not remove fine particles such as dust, pollen, and smoke. For this reason, they are best used in concert with other types of air filters (e.g. HEPA or MERV 13).

### KEY TAKEAWAY

Select filters with a minimum performance of MERV 13 for year-round air quality, and swap in even higher performing filters during poor air quality events.

## 04.7 Include a Refuge Area into Building Design

Designing one or more common areas inside a MURB as a refuge area can help build overall resilience to both air quality advisories and heat events.

Refuge areas help ensure that both occupants and where possible, community members at large have a place of respite in the event their own units become uncomfortable or unsafe. These spaces can be included alongside or in place of some of the more advanced strategies noted in this guide in order to provide a central refuge space for building occupants.

1

Design the space for enhanced seismic resilience

2

Ensure emergency supplies are provided, including food and potable water. Consider rainwater collection with filtration as a reliable source of water

3

Connect the refuge area to a low-carbon source of back-up power and storage

4

Provide higher levels of filtration, either in the form of centralized or portable filters

5

Connect the space to a source of mechanical heating and cooling

6

Set up the space to provide both private and social areas that are accessible to people living with different forms of disabilities, including an accessible washroom

7

Ideally, provide access to a treed area outside to provide shading, cooling, and improved air quality

8

Provide food storage and potable water, with potential connections to a rainwater collection system

9

Provide an accessible washroom for people of all different abilities

10

Plant outdoor vegetation that offers connection to nature

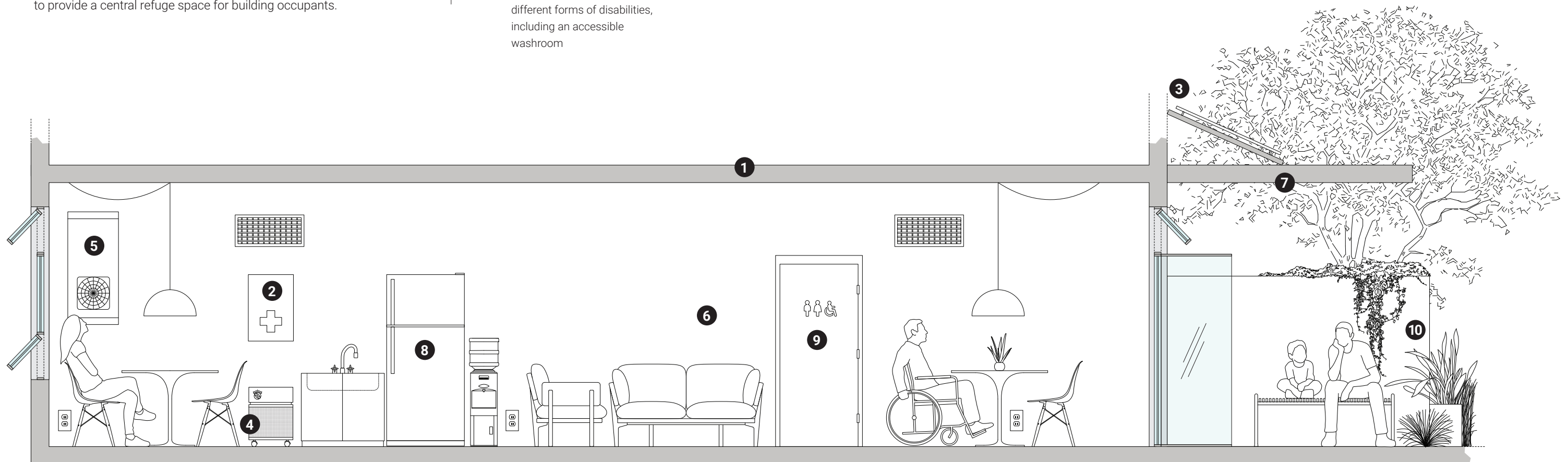

## CASE STUDIES

## Skeena Terrace

With 234 units constructed between 1960 and 1963, Skeena Terrace offers a variety of subsidized housing options in East Vancouver. While there is no active cooling provided to individual units, the complex has two spaces designed to act as refuge areas when necessary: one reading room of approximately 585 sf in a 6-storey building, and a larger amenity building in the central courtyard that serves all the tenants. During hot weather events, both spaces are equipped with portable air-conditioning units. These spaces were also designed to promote socializing between tenants and are used for community development programs delivered by BC Housing. Outside, the property offers ample greenspace for those looking to escape their warm units, with planting beds and a children's playground, and is generally well-shaded, including large trees planted along the west lot line.

**Right** Skeena Terrace, Vancouver, BC  
Underwood McKinley Cameron



# Appendix

- A1 Glossary of Terms
- A2 Image Sources



# A1 Glossary of Terms

**ACCEPTABILITY LIMITS** A specific indoor operative temperature at which the potential of overheating becomes a concern, which varies depending on the building's location.

**ACTIVATED CARBON** A method of air filtration that can remove volatile organic compounds (VOCs), odours, and other pollutants, but does not remove fine particles such as dust, pollen, and smoke. For this reason, they are best used in concert with other types of air filters (e.g. HEPA or MERV 13). An activated carbon filter must be replaced when its cleaning capacity has been used up.

**AIR-SOURCE HEAT PUMP** A highly energy efficient heat pump-based system that uses low-grade heat from the ambient air and uses it as a source of heat to condition building interiors.

**AIRTIGHTNESS** The measure of a building envelope's resistance to the leakage of air in or out of a building.

**BUILDING ENVELOPE (ENCLOSURE)** The elements that make up the outer shell of a building that separate indoor from outdoor spaces. A building's envelope prevents or controls the entry of heat, water, air, noise, and light from entering or leaving.

**CLIMATE ZONE** A region of the country defined by its average temperature (based on heating degree days). Climate zones in British Columbia range from Climate Zone 4 in Vancouver to Climate Zone 8 in the far north.

**COEFFICIENT OF PERFORMANCE (COP)** A measure of how efficiently a heat pump converts electricity into usable thermal energy.

**DEMAND CONTROL VENTILATION (DCV)** A system that automatically adapts the airflow rate in a space to the actual occupant load, based on the CO<sub>2</sub> exhaled by those occupants. By reducing the amount of fresh air brought in when occupant loads decrease, DCV can save energy and put less demand on the system.

**DRY BULB** The true thermodynamic temperature of the air when measured by a thermometer exposed to the air but shielded from radiation and moisture.

**ELECTROCHROMIC GLAZING** Technology that allows for automatic or manual control of a window's tint and solar heat gain properties.

**ENERGY EFFICIENCY** A measure of the effectiveness of energy use. A building with high energy efficiency requires less energy to perform the same tasks (e.g. heating, cooling, ventilation, etc.) as a building with lower energy efficiency.

**ENERGY RECOVERY VENTILATION (ERV)** A ventilation device that captures the energy from stale air as it leaves a building and uses the warmth to temper or pre-heat incoming fresh supply air before circulating it to occupants. It also captures some of the humidity in the air to help temper indoor climates — in summer, humidity is removed from incoming air prior to being injected into a building; in the winter, the reverse process occurs.

**FAÇADE** The exterior face of a building.

**GLAZING** Windows on a building.

**GLOBAL WARMING POTENTIAL (GWP)** A measure of how much heat a greenhouse gas traps in the atmosphere compared to carbon dioxide (CO<sub>2</sub>).

**GREENHOUSE GAS INTENSITY (GHGI)** A measure of the emissions intensity of a building's emissions, measured and expressed in tonnes or kilograms of carbon dioxide equivalent per square metre per year (CO<sub>2</sub>e/m<sup>2</sup>/year).

**GROUND SOURCE HEAT PUMP (GEOEXCHANGE)** A heat pump-based heating and cooling system that uses low-grade heat stored in the ground to condition interior building spaces.

**HEPA (OR HIGH-EFFICIENCY PARTICULATE AIR)** A type of air filter that works by forcing air through a fine mesh that traps harmful particles such as pollen, pet dander, dust mites, and smoke. To meet the HEPA standard, air filters must remove 99.97% of particulates greater than or equal to 0.3 µm from the air that passes through them.

**HEAT RECOVERY VENTILATOR (HRV)** A ventilation device that captures heat from stale exhaust air as it leaves a building and uses the warmth to temper or pre-heat incoming fresh supply air before circulating it to occupants.

**HIGH-RISE MURB** A multi-unit residential building of six storeys or higher, often designed and built using concrete construction techniques.

**HYDRONIC** The practice of using a water-based medium to distribute heat (providing both heating and cooling) throughout a building. Hydronic systems can use either radiators, in-floor systems, and in some cases, in-ceiling systems.

**MASSING** A building's general shape and size.

**MECHANICAL COOLING** Active systems that use energy to lower the temperature within a space, including heat pump systems, variable refrigerant flow systems, and mixed mode systems.

**MINIMUM-EFFICIENCY REPORTING VALUE (MERV)** A measurement scale designed by the American Society of Heating, Refrigerating and Air-Conditioning Engineers (ASHRAE) to rate the effectiveness of air filtration systems. The scale ranges from MERV 1 to MERV 20, depending on the minimum particle size that is filtered out of the air. Filters with efficiencies lower than MERV 13 are unlikely to provide protection from wildfire smoke.

**MURB** Multi-unit residential building

**NATURAL VENTILATION** The process of intentionally exchanging air in a building to replace stale air with fresh air from the building exterior, using non-mechanical means such as stack effect, cross ventilation, design elements, and operable windows.

**ORIENTATION** The way that a building is situated on a site, including the positioning of windows and rooflines, which can affect energy loads, solar heat gain, and thermal comfort.

**OVERHEATING** The state of high indoor temperatures in a building that can affect occupant thermal comfort, health and wellbeing, and productivity. Dangerously high temperatures can cause health risks, particularly in vulnerable populations. Toronto Public Health and Public Health England have both recommended that indoor temperature be no higher than 26°C.

**PART 3 BUILDING** A building over three storeys in height or over 600 square metres in footprint. Part 3 also includes some buildings of three storeys or less in height or under 600 square metres in area that are of a specific use. This includes larger buildings intended for residential, commercial, or industrial activities, as well as as well as buildings intended for public gatherings, residential care, or detention.

**PART 9 BUILDING** A building three storeys and under in height and with a footprint of 600 square metres or less. Part 9 buildings include small buildings intended for residential, commercial, or medium-to-low hazard industrial activities.

**PASSIVE SURVIVABILITY** A building's ability to maintain healthy, liveable conditions in the event of extended loss of power or water, or in the event of extraordinary heat waves, storms, or other extreme events.

**PEAK CONDITIONS** The instantaneous amount of heating or cooling that the building will require in order to maintain a specific indoor temperature during the coldest or warmest time of the year, respectively.

**RELIEF OPENING** In natural ventilation design, large openings at the top of a building that are used to vent warm air driven by the stack effect.

**SHADES** Systems installed on the exterior or interior of a building that are used to block unwanted solar heat gains. These can be manually-operated or automatically controlled.

**SHOCK** An acute natural or human-made event or phenomenon threatening major loss of life, damage to assets and a building or community's ability to function and provide basic services (e.g. heat wave, urban interface fire).

**SOLAR HEAT GAIN** The increase in thermal energy in a building as it absorbs incoming solar radiation.

**SOLAR HEAT GAIN COEFFICIENT (SHGC)** The fraction of solar radiation that is transmitted through a window, expressed as a number between 0 and 1. The lower the SHGC, the less solar heat the window transmits.

**STACK EFFECT** A phenomenon that occurs in taller buildings, this pressure differential between the interior and exterior drives the movement of interior air. Under cooler temperatures, it often creates positive pressure, which forces warmer air out of the enclosure at the upper portions of walls and the building and draws cooler air into lower portions.

**STRESS** A chronic (i.e. ongoing or cyclical) natural or human-made event or phenomenon that renders a building or community less able to function and provide basic services (e.g. increased average summer temperatures).

# A1 Glossary of Terms

**THERMAL COMFORT** The state where an occupant is satisfied with the temperature of a particular space. Thermal comfort is highly subjective and can depend on individual characteristics, behavioural factors, cultural norms, and environmental conditions.

**THERMAL ENERGY DEMAND INTENSITY (TEDI)** A measure of the total heating energy necessary to maintain a comfortable indoor temperature over the course of a year, expressed in kilowatt hours per square metre per year (kWh/m<sup>2</sup>/year).

**THERMAL RESILIENCE** The ability of a building's thermal conditions to adapt to the effect of power outages by using/modifying traditional active cooling, improving weatherization and insulation, increasing air circulation, reducing solar gains through windows, using natural ventilation, cooling external surfaces, minimizing internal heat gains, and cooling in place.

**TOTAL ENERGY USE INTENSITY (TEUI)** A measure of the total amount of energy used by a building over the course of a year, per unit of building area, measured and expressed in kilowatt hours per square metre per year (kWh/m<sup>2</sup>/year). TEUI encompasses all energy used in a building, including plug loads (e.g. lighting, appliances) and process loads (e.g. elevators, mechanical systems, and fans).

**UNMET COOLING HOURS** For spaces that make use of mechanical cooling, the time that a cooling system is unable to achieve the desired indoor temperature.

**U-VALUE** A measure of how well a building element conducts heat. The lower the U-value, the greater the material's insulating properties. U-values are expressed in SI units of W/(m<sup>2</sup>K) and U.S. units of BTU/(hr °F ft<sup>2</sup>). U value is the inverse of R value.

**VARIABLE REFRIGERANT FLOW (VRF)** A highly energy efficiency refrigerant-based heating and cooling technology.

**VULNERABLE POPULATIONS** Groups and communities at a higher risk for poor health as a result of the barriers they experience to social, economic, political, and environmental resources, as well as limitations due to illness or disability. These include children, pregnant women, elderly people, people with low incomes, and people who are ill or immunocompromised.

**WATER-SOURCE HEAT PUMP** Also known as ground source heat pumps, these are highly energy efficient heat pump-based systems that extract and dissipate heat using water or the ground. When compared

to air, the temperatures of these mediums remain relatively constant throughout the seasons, limiting variations in efficiency.

**WINDOW-TO-WALL RATIO (WWR)** The percentage of a building's façade that is made up of glazing.

## A2 Image Sources

### PAGE 14

*Vancouver Airport CWEC 2016*

**Source** [http://climate.weather.gc.ca/prods\\_servs/engineering\\_e.html](http://climate.weather.gc.ca/prods_servs/engineering_e.html)

### PAGE 15

*Global Average Surface Temperature Change*

**Source** Adapted from Figure SPM.7a from [http://www.climatechange2013.org/images/report/WG1AR5\\_SPM\\_FINAL.pdf](http://www.climatechange2013.org/images/report/WG1AR5_SPM_FINAL.pdf)

### PAGE 16

*1st and Clark, Vancouver, BC*

**Source** BC Housing/Focal Engineering

### PAGE 21

*3986 Norland Way, Burnaby, BC*

**Source** Horizon North/Focal Engineering

### PAGE 24

*Olympic Village, Vancouver, BC*

**Source** Susan MacDougall

### PAGE 26

*10 Buttertubs Drive, Nanaimo, BC*

**Source** Low Hammond Rowe Architects (LHRA) <https://www.lhra.ca/home/>

### PAGE 29

*Orion, Vidorra Developments, Pemberton, BC*

**Source** Dennis Maguire Architect / Rob Nadeau <http://orionpemberton.com/>

### PAGE 33

*Cambie Gardens, Vancouver, BC*

**Source** IBI Group <https://www.ibigroup.com/>

*Modello, Burnaby, BC*

**Source** Chris Dikeakos Architects Inc. <http://www.dikeakos.com/>

### PAGE 36

*Skeena Terrace, Vancouver, BC*

**Source** BC Housing

### ILLUSTRATIONS

*Assets for illustrations produced by Dimensions Guide*

**Source** <https://www.dimensions.guide/>